

eMOBILITY



FIT FOR FUTURE:
THE BEST TOOL
AND EQUIPMENT
FOR ELECTRIC MOBILITY



www.kstools.com



 **CERTIFIED SAFETY**

 **GUARANTEED QUALITY**

 **100% TESTED**

**OUR COMPETENCE
IS BASED ON EXPERIENCE
AND INNOVATION.**

**THEREFORE, YOU SHOULD
DECIDE FOR US!**

- Because we design and build premium tools
- Because safety has always been important to us
- Because we develop new products with a pioneering spirit
- Because we know what is required in practice
- Because our products are certified
- Because our logistics sets standards

TABLE OF CONTENTS

PERSONAL PROTECTIVE EQUIPMENT

22

HELMETS WITHOUT FACE PROTECTION	from page 24
FACE PROTECTION	from page 25
HELMETS WITH FACE PROTECTION	from page 26
PROTECTIVE CARRYING BAGS / ACCESSORIES	from page 27
GLOVES WITH PROTECTIVE INSULATION	from page 28
UNDERWEAR GLOVES FROM	from page 32
GLOVES FROM	from page 33
PROTECTIVE CARRIER BAGS / STORAGE	from page 33
CLEANING / TESTING	from page 36
BOOTS WITH PROTECTIVE INSULATION	from page 36

SURFACE INSULATION

38

RUBBER COVER CLOTH WITH PROTECTIVE INSULATION	from page 40
RUBBER FLOOR MAT	from page 42
PROTECTIVE CARRIER BAGS / STORAGE	from page 42
SIGNAGE AND MARKINGS	from page 46
BARRIERS	from page 48
RESCUE KITS	from page 50

MEASURING AND TESTING EQUIPMENT

52

VOLTAGE TESTER	from page 54
AMPERE PLIERS	from page 58
MULTIMETER	from page 59
INFRARED THERMOMETER	from page 61

ISOLATED TOOLS

62

KEYS WITH PROTECTIVE INSULATION	from page 64
1/4" TOOLS WITH PROTECTIVE INSULATION	from page 68
3/8" TOOLS WITH PROTECTIVE INSULATION	from page 71
1/2" TOOLS WITH PROTECTIVE INSULATION	from page 80
TORQUE WRENCH WITH PROTECTIVE INSULATION	from page 90
SCREWDRIVER WITH PROTECTIVE INSULATION	from page 92
SCREWDRIVER SETS WITH PROTECTIVE INSULATION	from page 95
PLIERS WITH PROTECTIVE INSULATION	from page 98
PLIER SETS WITH PROTECTIVE INSULATION	from page 107
CABLE SHEARS WITH PROTECTIVE INSULATION	from page 109
ELECTRICAL INSULATING TAPE	from page 118
STRIPPING PLIERS	from page 119
CRIMP TOOLS	from page 120
LED LAMPS WITH PROTECTIVE INSULATION	from page 126
TWEEZERS AND MIRRORS WITH PROTECTIVE INSULATION	from page 126

TOOL RANGES WITH PROTECTIVE INSULATED TOOLS

128

TOOL CASE WITH PROTECTIVE INSULATED TOOLS	from page 130
TOOL TROLLEY WITH PROTECTIVE INSULATED TOOLS	from page 140
LIFTING TECHNOLOGY	from page 149

CHARGING INFRASTRUCTURE

150

WALLBOXES	from page 162
ACCESSORIES FOR WALLBOXES	from page 170
WALLBOXES IN COMPARISON	from page 172
MOBILE CHARGER	from page 176
CHARGING CABLE	from page 180

ELECTROMOBILITY IS OUR PASSION, PASSION IS OUR DRIVE.



With manufacturing expertise, we offer high-quality tool solutions for professionals for safe use under high voltage – of individual articles up to ready-assembled workstations for repair and maintenance of Electric and hybrid vehicles. We are happy to go an extra round if you have individual wishes. We love challenges and make individual Solutions possible by arrangement!



BUILT FOR TODAY, READY FOR THE FUTURE



- Routine tested in accordance to DIN EN 60900 / IEC 60900:2004 submitted to 10 000 V dielectric strength
- Insulated protected two component handle with ergonomic handle design
- Soft, yellow component with micro structured surface
- Blade made out of S2 special steel - continuous hardened, phosphated and completely insulated

Handle colour: Yellow / red



- Routine tested in accordance to DIN EN 60900 / IEC 60900:2004 submitted to 10 000V dielectric strength
- Insulated protected two component handle with ergonomic hand protection
- Forged and tempered
- Head chrome plated, PTFE coating
- Precise machined, oil hardened and tempered
- Cutting edges inductively hardened
- Special quenched and tempered steel

Handle colour: Yellow / red



- Routine tested in accordance to DIN EN 60900 / IEC 60900:2004 submitted to 10 000V dielectric strength
- Two tone layer insulated protection with ergonomic hand protection
- Supported by the directive BGV A3 (VBG-4)
- Faulty isolation layer becomes visible by the yellow layer shining through
- Forged and tempered
- Head chrome plated
- Precise machined, oil hardened and tempered
- Cutting edges inductively hardened
- Special quenched and tempered steel

Handle colour: red

From the first idea to the last control, we do everything we can to use our tools as perfect as possible. Nothing less is our claim.

IDENTIFICATION STANDARDS



- For technical materials and ready- finished products according to GPSG (the Equipment and Product Safety Act).
- The marking stands for the security of the product with regards to electrical, mechanical, thermal, toxic, radiological and other endangering applications.
- Documents the conformity with VDE regulations and/ or European and/or international valid standards.



- All tools with double triangle marking are tested on 10 000 V piece by piece and approved with 10 fold security for 1000 V.

AC 1000V
IEC 60900:2004

- Is equivalent to DIN EN 60900 / IEC 60900:2004
- The international standard which describes the construction of insulated tools in detail (e.g., insulation, thickness). Furthermore individual tests (piece by piece tests) as well as series and random check tests are defined therein.
- Manufactured and examined for working processes at voltages up to AC 1000 V and DC 1500 V



INNOVATION AND QUALITY.

Our constantly growing innovative strength and the Increased quality awareness of customers demands a continuous improvement of product quality and Productivity. The pursuit of ever better Products are shared by all employees in our house.

EACH SINGLE PIECE-TESTED SECURITY YOU ARE LOOKING FOR BE ABLE TO RELY ON IT!



Voltage test

Insulated tools are examined individually (piece by piece). All tools with the identification mark are checked with AC 10.000 V and are admitted for 1.000 V. Safety is thereby guaranteed to multiple of 10!



Cold impact test

The toughness of the PVC material is checked by an impact weight while the tools are cooled down to -25°C . Afterwards no tears or damages may exist.



Testing of the electric insulation resistance

After 24 hours of underwater storage the tools with AC 10.000 V are tested for three minutes while simultaneously testing for current leakage is measured. For the duration of the test no breakdown of the insulation is accepted.



Pressure test

At a pressure load of 20 Nm and a temperature of 70°C no penetration of the insulation is allowed at test voltage of AC 5.000 V.



Testing of the adhesive power of the PVC coating

After being stored for 168 hours at 70°C the adhesive strength of the PVC coating on the pliers is checked with a tensile force of 500 Nm. After this test the insulation must still be remain snug and firm against the body.



Testing of flame resistance

In order to avoid any risk of fire hazard, the insulation material is made from flame resistant and self-extinguishing PVC material.

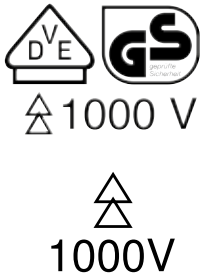

The isolated VDE tools of KS TOOLS are specially designed for the work on power lines coordinated. 1,000 volts flows through these Cables. In case of using normal tools this can cause severe physical damage, up to and including death can lead. Therefore, the use of isolated tools is mandatory.

HANDLE VARIANTS

2 Component safety handle in accordance to IEC 60900

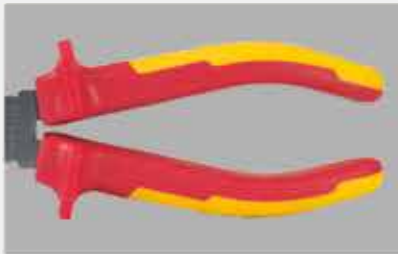

- Consists of a soft component for the gripping zone and a slightly harder component for the movement zone.
- A protection zone to the head side offers safe holding while pushing.
- All tools are admitted to 10 000 V testing piece by piece, with 10 fold security for 1 000 V. Approved for: AC 1000 V DC 1500 V
- Is equivalent DIN EN 60900 and normal VDE

Two tone repeated protection insulated in accordance to IEC 60900:2004



- Handle with inserted safety system supported by the directive BGV A3 (VBG-4). Before starting to work a sight test on externally recognizable losses must take place.
- Faulty isolation layer becomes visible by the yellow layer appearing
- All tools are admitted to 10 000 V testing piece by piece, with 10 fold security for 1 000 V. Approved for: AC 1000 V DC 1500 V
- Is equivalent DIN EN 60900 and normal VDE

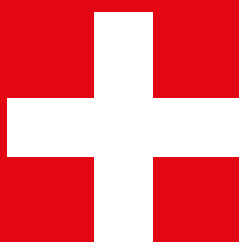

NOTHING IS MORE IMPORTANT TO US AS YOUR HEALTH

THE GUIDE BY THE JUNGLE OF STANDARDS

VDE

Association of Electrical And Electronic Engineering Information Technology e. V.

With the non-profit VDE testing and Zertifizierungsinstitut GmbH test the independent Inspector of the VDE Institute more than 100,000 devices and Tools per year. If the product passes the tests, it receives the VDE character, a triangle.

IEC

International Electrotechnical Commission

Technical Committees, Subcommittees and Working Groups develop international standards and Standards of electrical engineering. In the IEC, more than 80 countries represented, organized in 1442 Working groups and commissions.

CEI

Commission électrotechnique internationale

French-language designation of the IEC (see above).

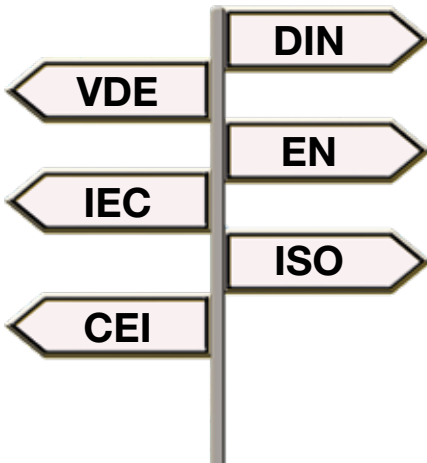

With the numerous standards, it is not so easy to keep an overview. But this is extremely important, when it is about the right tools and the right Protective equipment for high-voltage work goes. Therefore let's tell you what is behind the most important abbreviations hidden:

DIN

German Institute for Standardization e. V.

A DIN standard is a voluntary standard in which tangible and intangible assets standardised become. It shall be developed by a committee, checked and then released. DIN standards form a benchmark for flawless technical behaviour and are therefore within the framework of of the legal system.

EN

European Standard (EN)

They are ensed by the three European committees for standardisation (European Committee) for Standardisation (CEN), European Committee for electrotechnical standardisation (CENELEC) and the European Telecommunications Standards Institute (ETSI).

ISO

International Organization for Standardization

An ISO standard is one of the International Organization for Standardization (ISO) approved standard, which has to meet worldwide standards.

THE MOBILITY OF TOMORROW: A EXCITING WORLD

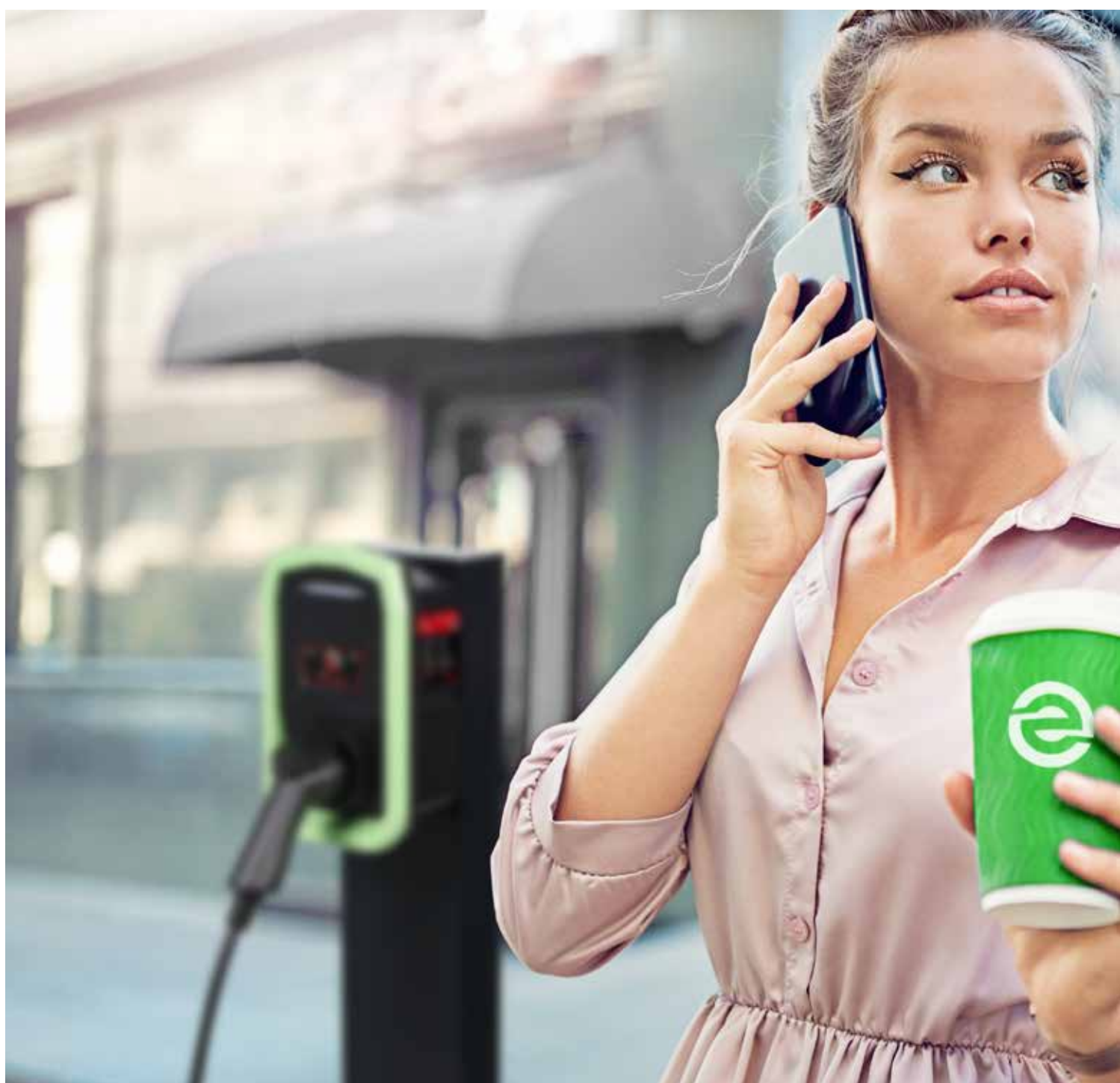

Electromobility is booming: one in ten newly registered passenger cars drives electrically, which Growth rate was over 330 percent in mid-2021! Overall, meanwhile, almost 600,000 electric cars on the road in Germany. Tendency naturally strong rising. Because the attractive funding programs of the Federal Government fuel the market during car-sharing vehicles and last-mile solutions a new creating awareness for electric mobility.



WHICH TYPES OF ELECTRIC VEHICLES IS THERE?

THE PURE ELECTRIC CAR (BEV)

Pure electric vehicles, after the abbreviation of the English term (»Battery Electric Vehicle«) are also called BEVs, use for the drive exclusively an electric motor. They obtain the required energy from a direct battery in the vehicle. This will be

charged via the power grid and can recover recovered Store braking energy. This process is called recuperation. With this drive variant the following models are offered: Smart ED, VW e-Golf, Tesla Model S or Renault ZOE.

RANGE EXTENDER (REEV)

Also the genus »Range Extended Electric Vehicle« (REEV) are electric vehicles. You have in addition to their battery, in addition to a Internal combustion engine, which is used as a range extender (»Range Extender«). This additional Engine drives the vehicle in contrast to the PHEV does not directly, but only delivers the power

for the battery. Reaches battery status its defined minimum range, the range Extender enabled to prevent the Vehicle while driving due to an empty Battery stops. Now the gasoline engine supplies the battery with electricity, which provides an additional range of about 100 km. Typical Range Extenders include the BMW i3 or the Ampera from Opel.

PLUG-IN HYBRID VEHICLE (PHEV)

Hybrid Electric Vehicle (HEV) use both an electric motor and a Internal combustion engine. Since they are externally connected to the power grid can be charged, they will be the Assigned to the category of e-mobiles – even if in this case, the conventional with the electrical Drive system is combined. At HEV, the Battery via the internal combustion engine or the recovered

braking energy (recuperation) loaded. PHEV models take advantage bothshortened distances (usually around the 50 km) completely electric, as well as other Comfortable routes with the help of the combustion engine to be able to cover. Well-known representatives of these Vehicle types include the Lexus 450 RX, the VW Passat Variant or the Mitsubishi Outlander.

Electric cars have different modes of operation and design features. If an e-mobile is to be operated economically, the respective driving behaviour can be included in the purchase decision. Not every model is suitable for all user habits. Basically distinguishes there are three vehicle variants: the pure electric vehicle, the range extender and the plug-in hybrid. In the following, the structure and essential features of this models explained.

HYBRID ELECTRIC VEHICLE (HEV)

Hybrids are vehicles that are used with a combustion engine and an electric motor are on the road. External charging on the power grid is not possible here. In general, the Electric motor the combustion engine above all when starting off, if this is a bad efficiency. This is how fuel consumption can be reduced by 15 – 25%. The difference between a classic hybrid and a plug-in

Hybrid consists in the fact that a full hybrid is only about very short distances can be operated purely electrically. However, recuperation can be used in this model type only be used when the battery is sufficient is charged and the electric drive from the controller is released. According to this principle of operation works z.B. the engine of the Audi A3 Sportback e-tron.

FUEL CELL VEHICLE (FCEV - FUEL CELL ELECTRIC VEH)

At FCEV, the electrical energy is generated during operation made of hydrogen and Oxygen. Here, a fuel cell is replaced by fed the hydrogen enduring storage in a tank. The components hydrogen and oxygen generate electrical energy by means of electrolysis Energy that drives the electric motor or also in of a battery. In this process there are no emissions. From the vehicle only water vapour escapes. Refuelling takes only a few minutes and is connected to the

classic Refuelling process comparable to petrol or diesel. The Range to be achieved is between 500 and 600 Km. However, since the production of fuel cells is changing as very energy-intensive and expensive, the ecological footprint despite the impressive Waterampf balance is not consistently positive. Therefore, only a few manufacturers offer corresponding Vehicles on: Exemplary here are the Hyundai NEXO and the Mercedes-Benz GLC F-Cell.

HOW DO YOU DETERMINE THE RANGE OF AN E-MOBILE?

Quite simply with the formula »Battery capacity, divided by energy consumption per 100 km, times 100«.

Or as an example: Does a vehicle with the battery capacity of 50 kWh over the

Energy consumption of 16 kWh per 100 km, then resulted in the calculated range of 312 km. However, this is only a theoretical value. Factors such as Driving behaviour, track conditions or payload influence the vehicle performance and thus lead to deviations.

VOLTAGE IS NOT THE SAME VOLTAGE

ON-BOARD CHARGING SYSTEM (OBC)

Converts the current from a Household socket comes in 240 volts DC.

BATTERY

Voltages between 300 and 800 volts DC

HEATING AND AIR CONDITIONING SYSTEM

Voltage above 300 volts AC

AUXILIARY BATTERY

12 Volt DC

DRIVE

Voltages above 300 volts
Alternating current

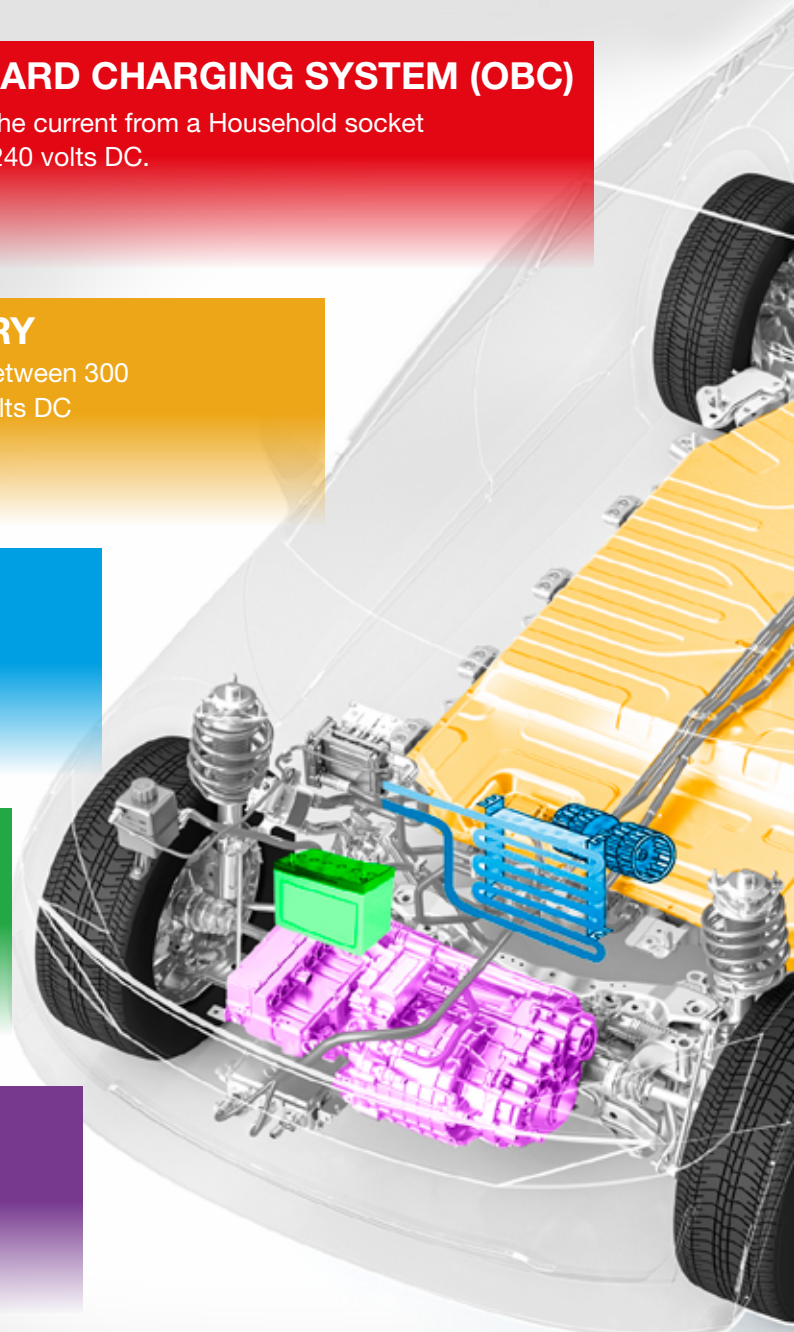

The voltage sources in electric vehicles are numerous – and very different!

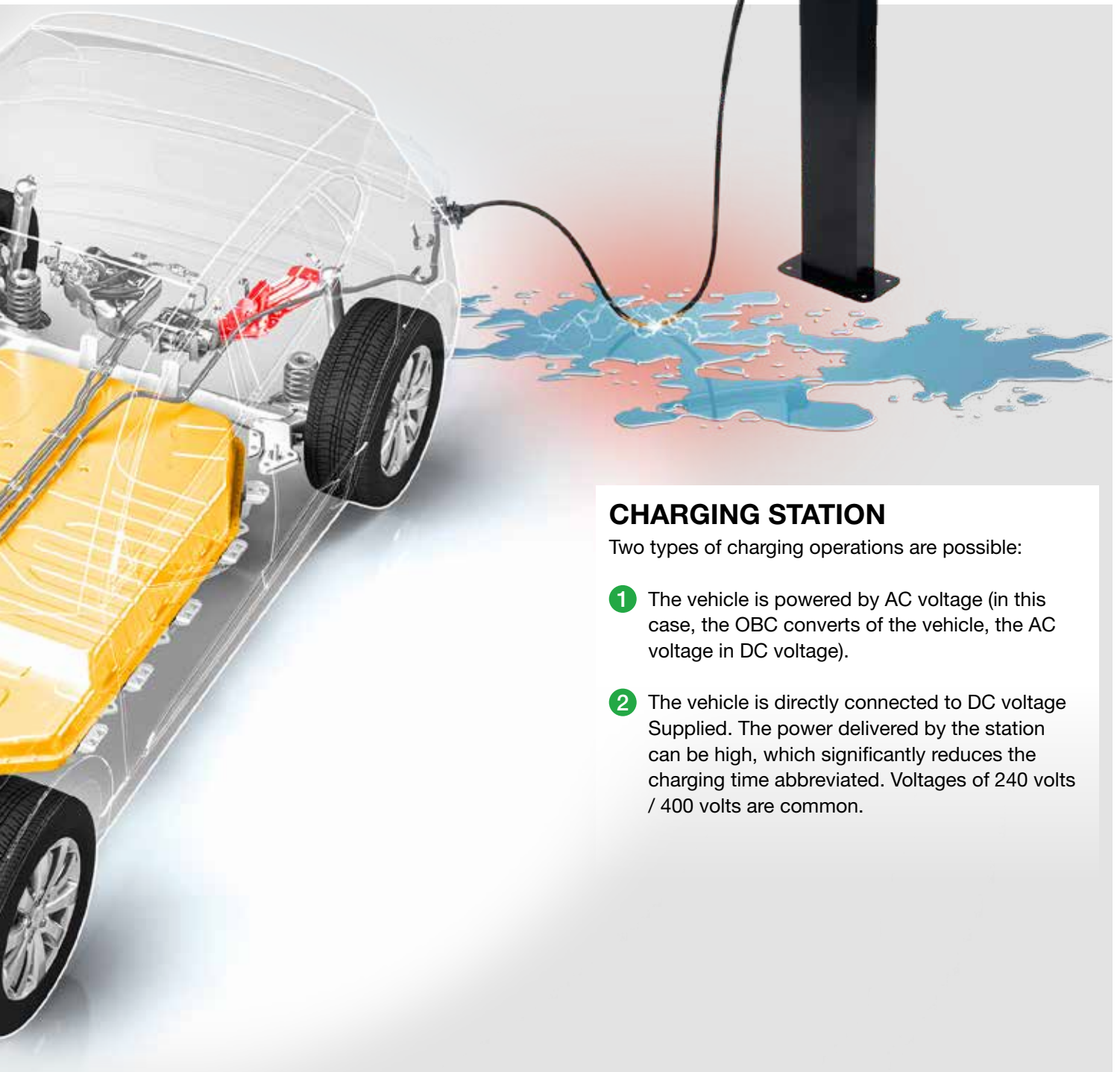

CHARGING STATION

Two types of charging operations are possible:

- 1 The vehicle is powered by AC voltage (in this case, the OBC converts of the vehicle, the AC voltage in DC voltage).
- 2 The vehicle is directly connected to DC voltage Supplied. The power delivered by the station can be high, which significantly reduces the charging time abbreviated. Voltages of 240 volts / 400 volts are common.

CHARGING CABLE AND PLUG FOR ELECTRIC VEHICLE

CHARGING CABLES FOR ELECTRIC VEHICLES

MODE 2 CHARGING CABLE

At the factory, most vehicles are processed by respective manufacturer with a Mode 2 charging cable equipped. In principle, this allows an Electric car also via the household socket load. The cable has at one end of the connector via a commercially available Schuko plug, on the other end is the appropriate plug to your car model. From a security perspective and charging time is not recommended, because the flowing energy flows are clear are to be classified higher than in the case of the conditioning of a classic household appliance. An in-cable control Box (ICCB) is placed between the vehicle plug and connectiontecker and acts as Communicator between the electric vehicle and the charging port.

MODE 3 CHARGING CABLE

The work is much faster and more comfortable Charging process with the Mode 3 charging cable via a so-called wallbox. Here is the cable mostly firmly integrated and enables charging capacities of up to 43 kW. When purchasing an e-mobile, but this consideration does not matter. Decisive for charging the vehicle is the type of plug required. Since the Type 2 plug is standard in Europe, charging stations are often with a type 2 Socket equipped. Here- with can both Type 1 electric vehicles (Asian and US american Passenger cars) as well as type 2 (European) can be loaded.

WHICH PLUG FOR WHICH ELECTRIC CAR?

TYPE 1 PLUG



The single-phase type 1 connector with a Charging power of up to 7.4 kW (230 V, 32 A) is found as a standard primarily in Car models from the Asian or U.S. room use. This one with five contacts Plug communicates via two Current conductor and is suitable for single-phase Charging with a voltage of 110 or 230 volts. Exist in Europe however, hardly any charging stations for this with a fixed Type-1-Charging cable.

TYPE 2 PLUG



The three-phase type 2 connector with a Charging power of up to 22 kW (400 V, 32 A) in the private environment and up to 43 kW (400 V, 63 A) at public charging stations, is in the European area most widespread and is considered standard in this country. He is also known as the Mennekes plug. At the Most public charging stations can be Connect a Mode 3 cable, which allows both e-mobiles with type 1 and type Allow 2 plugs to charge. Is the station connected via the three-phase power grid, goes charging much faster. In addition, type is 2 secured against unauthorised removal.

COMBO PLUG

(Combined Charging System CCS)



The combo plug (CCS) has two supplementing power contacts and extends the type 2 plug with it a fast charging function. This plug supports AC and DC charging (AC and DC charging) theoretically with up to 400 kW. Regular in practice, this value is more likely to rank at 50 kW.

TESLA SUPERCHARGER



Tesla's Supercharger is considered a modified Variant of the Mennekes plug Type 2. In just 30 minutes, it enables 80% charging of the Tesla Model S with a charging power of up to 120 kW (direct current). Become a Tesla Supercharger so far not for other vehicle makes Offered. For Tesla customers, this will Charging at public charging stations as free service offered.

CHADEMO PLUG



This is a fast charging system, developed in Japan and comparable to the CSS system is. It also allows Charging capacities of up to 400 kW but is rare in Europe to be encountered.

PLUGS FOR AT HOME, IN WORKSHOPS AND AT PUBLIC CHARGING STATIONS

SCHUKO SOCKET



At public charging stations, sometimes conventional household sockets (Schuko sockets) installs. They allow charging of all electric vehicles via one fashion 2 charging cables. To achieve a charging power from up to 3.7 kW (230 V, 16 A) to, an additional Hedge. Without prior verification the socket is recommended a maximum charging power of 2.3 kW (230 V, 10 A).

CEE PLUG



A distinction is made here between the single-phase, blue variant, which is often used in the camping sector and with a Charging power of up to 3.7 kW (230 V, 16 A). The three-phase, red Version for industrial sockets is offered in two versions: While the small industrial plug (CEEI 6) Charging capacities of up to 11 kW (400 V, 16 A), the large (CEE32) charging capacities of up to to 22 kW (400 V, 32 A).

PERSONAL PROTECTIVE EQUIPMENT

Working under tension is a matter of the mind. Therefore, you will find on the following a selection of safety helmets and face shields that ensure that that you always keep a cool head can.

Well protected from head to toe: This guarantees the personal protector equipment from KS TOOLS. In the event of an emergency, protect the helmets presented here and visors in front of flying sparks and electric arcs – of course DIN certified!

ACTIVE PREDECTION IN THE EVENT OF ARC FAULTS

PREDECTS AGAINST HEAT AND FLYING PARTICLES

COMFORTABLE TO WEAR THROUGH PERFECT ERGONOMICS



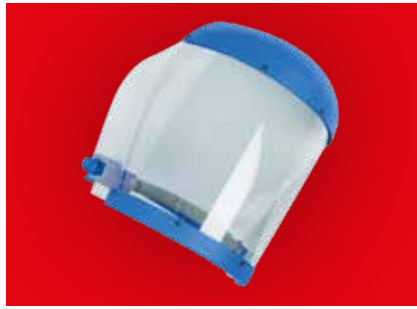

HELMETS WITHOUT FACE PROTECTION





117.1608 ... 1610

PROTECTIVE HARD HAT

- DIN EN 50365 CE 0340
- Safety helmet according to EN 50365: 2002-11
- electrical insulation 1.000 V AC
- adjustable from 51 - 64 cm

1000V



	Color		Price
117.1608	white		53,00 €
117.1609	yellow		53,00 €
117.1610	red		53,00 €

53,00
EUR





117.0020 ... 0023

PROTECTIVE HARD HAT

- DIN EN 50365
- electrical insulation 1,000 V AC
- removable headband,
- adjustable from 53 - 63 cm with fastening device
- for accessories

1000V



	Color		Price
117.0020	white		18,00 €
117.0021	blue		18,00 €
117.0022	red		18,00 €
117.0023	yellow		18,00 €

18,00
EUR

FACE PREDECTION

117.1780

ELECTRICIAN'S FACE SHIELD, CLASS 1

- DIN EN 166: 2001
- Fault arc tested to DGUV GS-ET-29, test level W(LBP) = 318 kJ (corresponds to prospective test short-circuit current 7 kA/0.5 s) EN 166
- Face protection for 117.1608 -117.1610



183,00
EUR

Arc fault	
117.1780	Class 1

117.1796

ELECTRICIAN'S FACE SHIELD, CLASS 2

- DIN EN 166: 2001
- Fault arc tested to DGUV GS-ET-29, test level W(LBP) = 318 kJ (corresponds to prospective test short-circuit current 7 kA/0.5 s) EN 166
- Also fault arc tested to ASTM F2178, ATPV: 7.0 cal/cm²
- Suitable for standard electrician's hardhat
- Size adjustment is made by rubber band



315,00
EUR

Arc fault	
117.1796	Class 2

117.0224

FACE SHIELD WITH HEAD BAND

- DIN EN 166: 2001
- EN 167 / EN 168 / EN 170
- Size adjustment is made by rubber band
- Face protection for 117.0020 -117.0023

1000V



Caution! Eyeglasses do not protect from short-circuit arc flashes

91,50
EUR



HELMETS WITH FACE PROTECTION

117.0118 ... 0139

PROTECTIVE HARD HAT WITH FACE SHIELD

- Helmet: DIN EN 397 / EN 50365
- electrical insulation 1.000 V AC
- Face protection: DIN EN 166 / EN 167 / EN 168 / EN 170
- Helmet with face protection: GS-ET-29
- Size adjustment is made by rubber band

1000V



277,50 EUR

	Color	⚡	Price
117.0118	white	1000V	277,50 €
117.0135	blue	1000V	277,50 €
117.0136	yellow	1000V	277,50 €
117.0137	red	1000V	277,50 €
117.0139	green	1000V	277,50 €

117.0003 ... 0004

PROTECTIVE HARD HAT WITH ARC FLASH LIGHT FACE SHIELD

- Helmet: DIN EN 397 / EN 50365
- Face protection: Fault arc tested to DGVU GS-ET-29, test level W(LBP) = 318 kJ (corresponds to prospective test short-circuit current 7 kA/0.5 s) EN 166
- adjustable from 53 - 63 cm

1000V



	ATPV	⚡	Price
117.0003	8,4 CAL/cm ²	1000V	req.
117.0004	24 CAL/cm ²	1000V	req.

PREDECTIVE CARRYING BAGS / ACCESSORIES

117.1612

CARRY BAG FOR WORK HELMET

- Made out of red leather
- With carrying strap

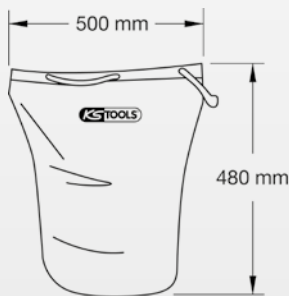

77,00
EUR

117.0106

CARRY BAG FOR HELMET

- perfect for storage
- Tanka closure for quick opening and closing of the bag



20,00
EUR

150.4410

PERFECTLIGHT HEADLAMP WITH MOTION SENSOR, 120 LUMEN

- Extremely powerful light CREE XP-G2 front LED
- 120 lumen luminous flux
- Motion sensor for switching on and off
- Ingress protection according to IP54
- Includes 3 x AAA 1,5V batteries



req.

GLOVES WITH PREDECTIVE INSULATION

FINDING THE GLOVES YOU NEED

We offer three types of glove with different levels of predection:

- Gloves with electrical predection only (to be used in conjunction with over gloves for mechanical predection).
- Gloves with integrated electrical and mechanical predection (two in one).
- Gloves with integrated electrical and mechanical predection, plus arc predection (three in one).

Special properties may be useful for providing additional predection during electrical work: A (acid), H (oil), Z (ozone), R (A + H + Z), C (very low temperature); most of our gloves belong to the RC category.

It's very important to chose the right size in order to get the highest dexterity. Many sizes are availfromle (6 to 12 depending on the class), so to let gloves suitfromle for ladies or big mens. Standard lengths are 28 cm, 36 cm and 41 cm.

INSPECTION

Periodic

Our insulating gloves have no expiry date and can be used as long as they pass periodic inspections. We recommend testing gloves in service every six months and gloves in stock every 12 months; the recommended method of testing is visual inspection and dielectric testing. More informations are availfromle on the instructions for use.

Recommendations before use

Full visual inspection of each glove. Use a manual air pressure device for testing the glove by inflating it and thus detecting any defects.

If a glove is defective, both the gloves of the pair must be rejected from use and checked by a trained person.



Our gloves are manufactured with a water based technology (no use of solvents).

GENERAL INFORMATION

According to applicfromle standards EN 60903 and IEC 60903

Class	Voltage recommended DC (max)	Voltage recommended DC (max)
00	500 V	750 V
0	1000 V	1500 V
1	7500 V	11,250 V
2	17,000 V	25,500 V
3	26,500 V	39,750 V
4	36,000 V	54,000 V

MEANING OF THE MARKING ON EACH GLOVE

example of a composite glove, with the ,hammer' pictogram in addition

Kategorie	Empfohlene Spannung AC (max)
A	Acid
H	Oil
Z	Ozone
R	Acid, Oil, Ozone
C	Very low temperature
Mechanical predection	

Note 1:
The R category combines the characteristics of categories A, H and Z

Note 2:
Any combination of categories may be used

IEC 60417-5216 live working pictogram

Symbol for mechanical predection (composite gloves only)

EN 60903:2003 IEC 60903: 2014

CE 0333

Third party notified body no.

Made in France

Room for writing new last/next inspection date or date of issuing into service

Trademark logo

FLEX&GRIP

GLB4-41-10

Item number

10

Size

4 / RC

Category Class

MM/YY

Month/Year of manufacture

LLLL

Batch number

U_{max} = xxxxx V AC

Maximum usage voltage

HOW TO FIND YOUR GLOVE SIZE!

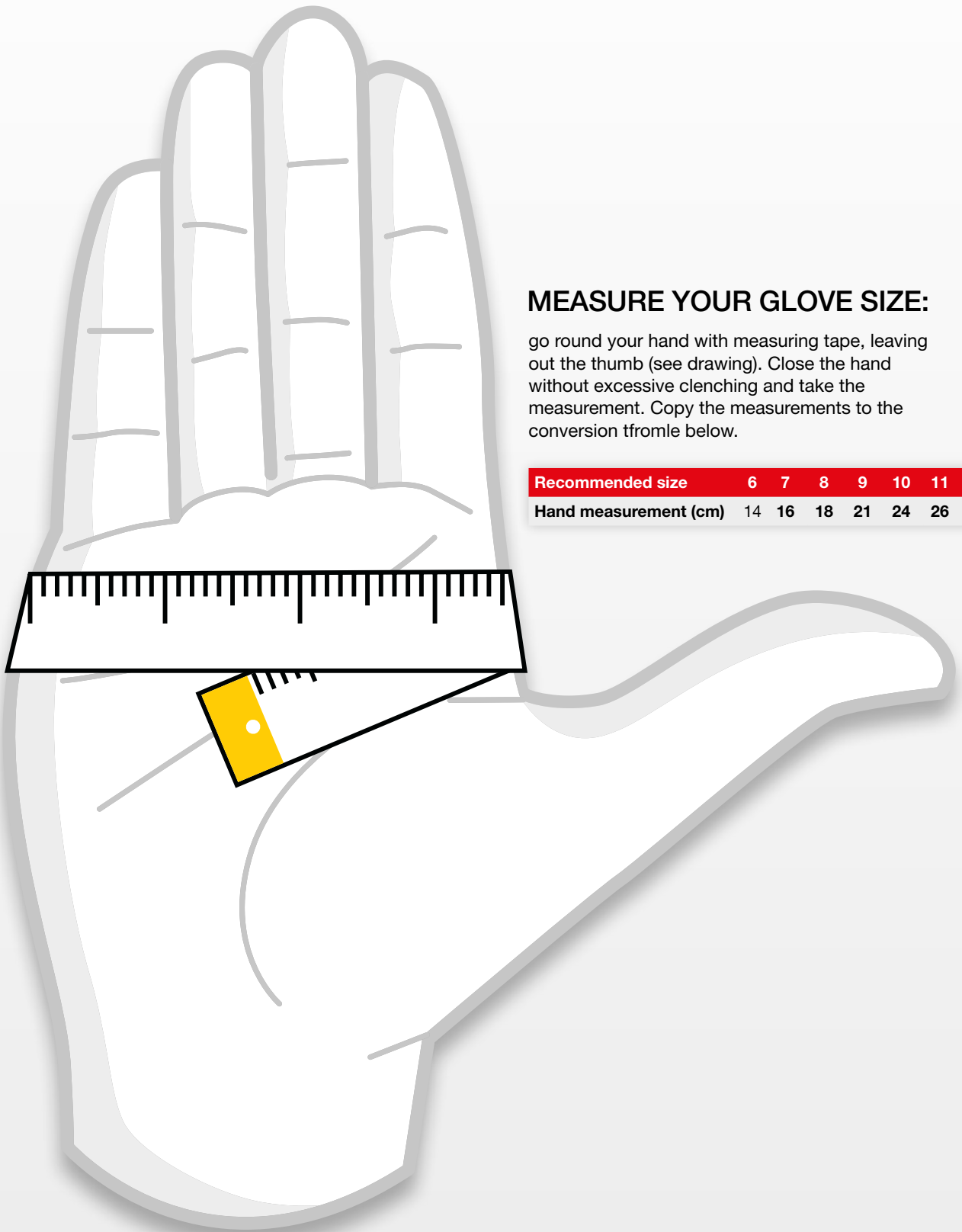

MEASURE YOUR GLOVE SIZE:

go round your hand with measuring tape, leaving out the thumb (see drawing). Close the hand without excessive clenching and take the measurement. Copy the measurements to the conversion table below.

Recommended size	6	7	8	9	10	11	12
Hand measurement (cm)	14	16	18	21	24	26	28

117.0048 ... 0065

GLOVE FOR ELECTRICIANS WITH PROTECTIVE INSULATION

- Insulation according to DIN EN 60903
- **Attention:** Over-gloves required for mechanical protection!

1000V



start from **57,50** EUR

117.0066 ... 0083

GLOVE FOR ELECTRICIANS WITH PROTECTIVE INSULATION

- Insulation according to DIN EN 60903

1000V



start from **110,50** EUR

	Size	Color	Electrosoft Class	L mm		Price
117.0048	10	white	00	360	500 V	57,50 €
117.0049	11	white	00	360	500 V	57,50 €
117.0050	12	white	00	360	500 V	57,50 €
117.0051	10	white	0	360	1000 V	74,00 €
117.0052	11	white	0	360	1000 V	74,00 €
117.0053	12	white	0	360	1000 V	74,00 €
117.0054	10	white	1	360	7500 V	104,00 €
117.0055	11	white	1	360	7500 V	104,00 €
117.0056	12	white	1	360	7500 V	104,00 €
117.0057	10	white	2	360	17000 V	127,00 €
117.0058	11	white	2	360	17000 V	127,00 €
117.0059	12	white	2	360	17000 V	127,00 €
117.0060	10	white	3	360	26500 V	161,50 €
117.0061	11	white	3	360	26500 V	161,50 €
117.0062	12	white	3	360	26500 V	161,50 €
117.0063	10	white	4	410	36000 V	254,00 €
117.0064	11	white	4	410	36000 V	254,00 €
117.0065	12	white	4	410	36000 V	254,00 €

	Size	Color	Electrosoft Class	L mm		Price
117.0066	10	red	00	360	500 V	110,50 €
117.0067	11	red	00	360	500 V	110,50 €
117.0068	12	red	00	360	500 V	110,50 €
117.0069	10	red	0	360	1000 V	112,50 €
117.0070	11	red	0	360	1000 V	112,50 €
117.0071	12	red	0	360	1000 V	112,50 €
117.0072	10	red	1	360	7500 V	138,50 €
117.0073	11	red	1	360	7500 V	138,50 €
117.0074	12	red	1	360	7500 V	138,50 €
117.0075	10	red	2	360	17000 V	161,50 €
117.0076	11	red	2	360	17000 V	161,50 €
117.0077	12	red	2	360	17000 V	161,50 €
117.0078	10	red	3	360	26500 V	231,00 €
117.0079	11	red	3	360	26500 V	231,00 €
117.0080	12	red	3	360	26500 V	231,00 €
117.0081	10	red	4	410	36000 V	312,00 €
117.0082	11	red	4	410	36000 V	312,00 €
117.0083	12	red	4	410	36000 V	312,00 €

117.0084 ... 0101

GLOVE FOR ELECTRICIANS WITH PROTECTIVE INSULATION

- Insulation according to DIN EN 60903
- IEC 61482-1-2 class 2 (0,5s – 7kA)

1000V



start from **127,00** EUR



	Size	Color	Electrosoft Class	L mm	⚡	Price
117.0084	10	red	00	360	500 V	127,00 €
117.0085	11	red	00	360	500 V	127,00 €
117.0086	12	red	00	360	500 V	127,00 €
117.0087	10	red	0	360	1000 V	138,50 €
117.0088	11	red	0	360	1000 V	138,50 €
117.0089	12	red	0	360	1000 V	138,50 €
117.0090	10	red	1	360	7500 V	161,50 €
117.0091	11	red	1	360	7500 V	161,50 €
117.0093	10	red	2	360	17000 V	161,50 €
117.0094	11	red	2	360	17000 V	196,50 €
117.0095	12	red	2	360	17000 V	196,50 €
117.0096	10	red	3	360	26500 V	196,50 €
117.0097	11	red	3	360	26500 V	254,00 €
117.0098	12	red	3	360	26500 V	254,00 €
117.0092	12	red	1	410	7500 V	254,00 €
117.0007	10	red	0	410	1000 V	138,50 €
117.0008	11	red	0	410	1000 V	138,50 €
117.0009	12	red	0	410	1000 V	138,50 €
117.0010	10	red	2	410	17000 V	196,50 €
117.0011	11	red	2	410	17000 V	196,50 €
117.0012	12	red	2	410	17000 V	196,50 €
117.0013	10	red	3	410	26500 V	254,00 €
117.0014	11	red	3	410	26500 V	254,00 €
117.0015	12	red	3	410	26500 V	254,00 €
117.0099	10	red	4	410	36000 V	346,00 €
117.0100	11	red	4	410	36000 V	346,00 €
117.0101	12	red	4	410	36000 V	346,00 €

UNDERWEAR GLOVES

117.0126

TALC CONTAINER, 50 G

- prevents sticking together and Brittle be of latex

**8,00**
EUR

117.1660

UNDER GLOVES

- Made out of fine mutton cloth
- Material: stretch
- Size: universal

**11,50**
EUR

GLOVES

117.0141 ... 0145

PULL-ON GLOVES FOR ELECTRICIAN'S
PROTECTIVE GLOVES

- EN 420 / EN 388
- to protect against mechanical risks
- Abrasion stage 2
- Stage cut 1
- Stage train 2
- Pierce stage 2

**44,00**
EUR

	for Size	Price
117.0141	7	46,00 €
117.0142	8 + 9	46,00 €
117.0143	10	46,00 €
117.0144	11	46,00 €
117.0145	12	46,00 €

PREDECTIVE CARRIER BAGS

117.1665

PROTECTION POCKET
FOR ELECTRICIANS
GLOVES

- Belt pocket made out of canvas
- For the storage and protection of the Electricians gloves

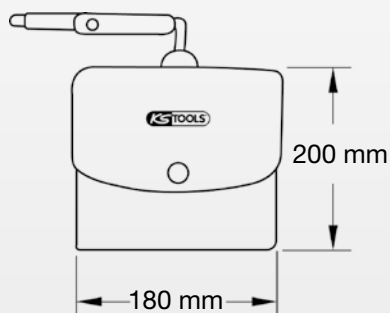
**88,50**
EUR

117.0125

PROTECTIVE CASE FOR INSULATING GLOVES



117.0148

BOX FOR ISOLATING GLOVES



117.0212

ROLLING BACKPACK

- ideal for accommodating and storing personal protective equipment and tools
- with identification / address field
- with castors and feet for a better stand
- Handle with telescopic extension
- Internal volume up to 25 liters

693,50
EUR



117.0213

BACKPACK

- ideal for accommodating and storing personal protective equipment and tools
- padded shoulder straps
- Internal volume up to 25 liters

497,00
EUR



* Helmet not included

BOOTS WITH PREDECTIVE INSULATION

117.1613 ... 1621

SAFETY RUBBER BOOTS WITH PROTECTIVE INSULATION

- For working enviroment of voltages AC 1000 V and DC 1500 V
- In accordance with new standard EN 50321
- With steel bar



249,50
EUR

	Size		Price
117.1613	39		249,50 €
117.1614	40		249,50 €
117.1615	41		249,50 €
117.1616	42		249,50 €
117.1617	43		249,50 €
117.1618	44		249,50 €
117.1619	45		249,50 €
117.1620	46		249,50 €
117.1621	47		249,50 €

CLEANING / TESTING

117.0149

RUBBER CLEANER, 200 ML

- ideal for cleaning electrician's protective gloves
- removes dirt and dust
- a microfiber cloth is recommended for wiping



39,00
EUR

117.0133

CLEANING AND DISINFECTION KIT 200 + 200 ML

- ideal for cleaning and disinfection of electrician's gloves
- Broad spectrum of activity and is used as a bactericide, fungicide, yeasticide and virucide
- Biocidal active: IDECYLDIMETHYLAMMONIUM CHLORIDE
- removes dirt and dust
- a microfiber cloth is recommended for wiping



92,50
EUR

117.1724

PNEUMATIC ELECTRICIAN PROTECTIVE GLOVE TESTER

- for the testing of insulated gloves
- always carry out before starting work
- bellows made of NBR
- test diameter 130 mm

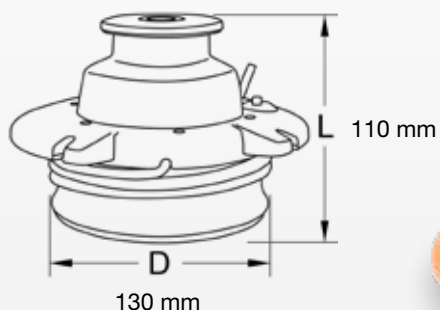

570,50
EUR

SURFACE INSULATION

When working on vehicles with electric or Hybrid drive is safety of the employees always in the first place. The equipment of the workplaces comes that is why it is important to ensure that all legally prescribed requirements be fulfilled.

From the sleeping mat to rubber drapes to warning signs and first aid posters: On the upcoming pages you will find everything you need, to a high-voltage workstation in accordance with the regulations secure.

**INSULATING WORKPLACE
EQUIPMENT**

WORKPLACE IDENTIFICATION

GUIDE BEAMS & BARRIER POSTS

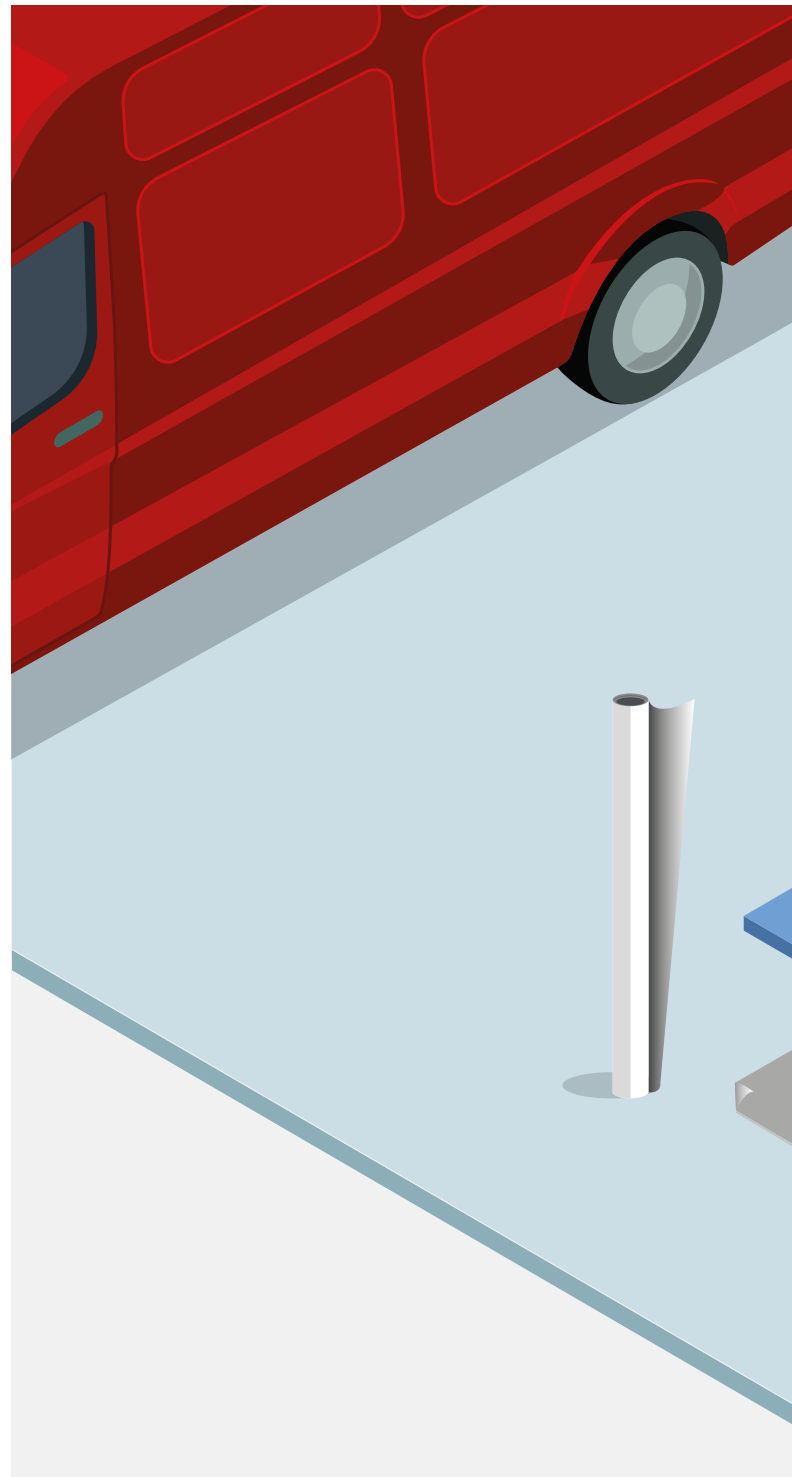

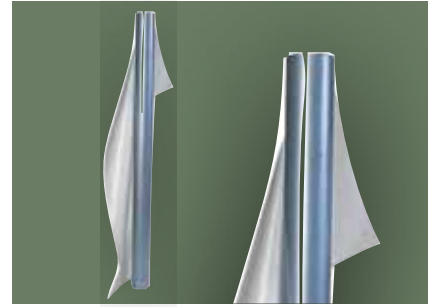

RUBBER COVER CLOTH WITH PREDECTIVE INSULATION

117.2303 ... 2311

REPAIR TAPE WITH PROTECTIVE INSULATION, TRANSPARENT

- Insulation according to DIN EN 61112
- transparent cloth
- cold-resistant and highly flexible



1000V

start from **11,50** EUR

	mm	⚡	Price
117.2303	130 x 130	1000V	11,50 €
117.2304	200 x 200	1000V	23,00 €
117.2305	250 x 350	1000V	26,00 €
117.2306	500 x 500	1000V	62,50 €
117.2307	600 x 600	1000V	78,00 €
117.2308	1000 x 1000	1000V	169,50 €
117.2309	1200 x 1200	1000V	203,00 €
117.2311	50000 x 1300	1000V	14.092,00 €

117.0156 ... 0157

RUBBER COVER SHEET WITH PROTECTIVE INSULATION, TRANSPARENT

- Insulation according to DIN EN 61112

1000V



start from **219,50** EUR

	L x B mm	Price
117.0156	12500 x 1300	219,50 €
117.0157	25000 x 1300	416,00 €

117.1651 ... 1753

RUBBER-REPAIR TAPE WITH PROTECTIVE INSULATION

- Tested to VDE 0680/1
- Insulated to DIN EN 60903
- Extensively tear and water resistant
- Particularly suitable for external usage

1000 V

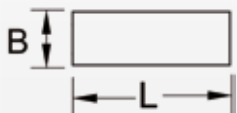

start from **11,00** EUR

	Thickness	L x B mm	⚡	Price
117.1651	1,0	130 x 130	1000V	11,00 €
117.1652	1,0	350 x 250	1000V	33,50 €
117.1653	1,0	500 x 500	1000V	92,50 €
117.1654	1,0	600 x 600	1000V	128,00 €
117.1655	1,0	1000 x 1000	1000V	305,50 €
117.1656	1,0	1000 x 1200	1000V	403,50 €
117.1657	1,0	10000 x 1000	1000V	2.633,00 €
117.1658	1,0	10000 x 1200	1000V	3.465,50 €

	Thickness	L x B mm	⚡	Price
117.1746	1,6	130 x 130	1000V	11,00 €
117.1747	1,6	350 x 250	1000V	32,50 €
117.1748	1,6	500 x 500	1000V	91,50 €
117.1749	1,6	600 x 600	1000V	122,00 €
117.1750	1,6	1000 x 1000	1000V	268,50 €
117.1751	1,6	1000 x 1200	1000V	399,00 €
117.1752	1,6	10000 x 1000	1000V	2.887,50 €
117.1753	1,6	10000 x 1200	1000V	2.887,50 €

117.0158 ... 0160

INSULATING VELCRO BLANKET

- ST TST BT 410
- ideal for covering exposed conductors or other conductors are defective or not properly insulated
- it can also be used several Velcro ceiling to create a denser protective layer



start from **52,00** EUR

	L x B mm	Price
117.0158	660 x 360	52,00 €
117.0159	900 x 500	81,50 €
117.0160	1200 x 800	138,50 €

117.0161 ... 0163

PLASTIC CLAMP WITH PROTECTIVE INSULATION

- for fixing temporary protective blankets

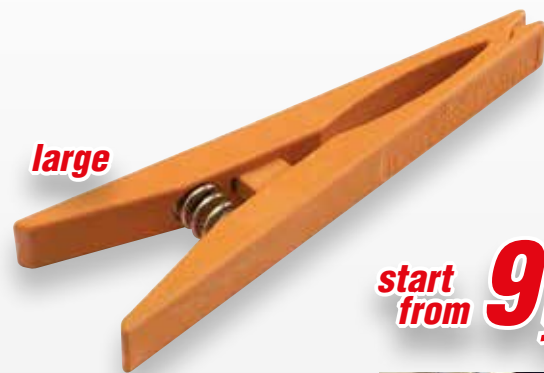

start from **9,00** EUR



	Clipping capacity	L x B mm	Price
117.0161	25 mm	165 x 18	9,00 €
117.0163	10 mm	67 x 22	13,00 €

117.1643 ... 1644

PLASTIC FLAT NOSE PLIERS WITH PROTECTIVE INSULATION

- Insulated to IEC 60900
- For clamping of uncovered cable



	Clipping capacity	L x B mm	⚡	Price
117.1643	10	80 x 15		24,00 €
117.1644	27	160 x 16		24,00 €

RUBBER FLOOR MAT

117.3819 ... 1755

INSULATING MAT

- Insulation in accordance with IEC 61111 Class 2



start from **98,00** EUR

	Thickness mm	L x B mm	⚡	Price
117.3819	3,0	1000 x 1000	⚡ 1000V	98,00 €
117.1398	3,0	1000 x 10000	⚡ 1000V	704,50 €
117.1754	4,5	1000 x 1000	⚡ 1000V	157,00 €
117.1755	4,5	1000 x 10000	⚡ 1000V	1.294,00 €

117.0151 ... 0153

INSULATING MAT

- Insulation in accordance with IEC 61111 Class 0

⚡
1000V



	L x B mm	⚡	Price
117.0151	600 x 600	⚡ 1000V	req.
117.0130	1000 x 1000	⚡ 1000V	req.
117.0152	1000 x 1000	⚡ 1000V	req.
117.0153	10000 x 10000	⚡ 1000V	req.



PREDECTIVE CARRIER BAGS / STORAGE

117.0154

TRANSPORT CASE FOR INSULATING MATS

- made of PVC-coated polyamide canvas
- with removable carrying straps



92,50 EUR

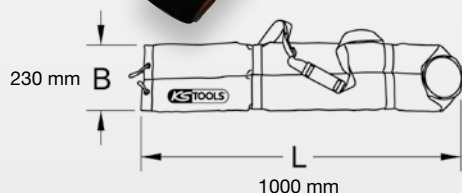

117.0155

TRANSPORT STRAP FOR INSULATING MATS

- adjustable
- ultra lightweight



11,50 EUR

	max. Ø mm	Belt length max. mm
117.0155	130	1120

* without isostand mat

117.1399

PROTECTIVE BAG FOR INSULATING MAT

- Made out of red leather
- With carrying strap

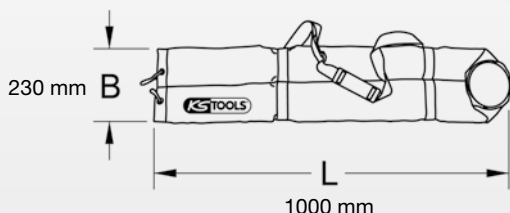

156,00
EUR

117.4234 ... 4240

SLEEVE WITH PROTECTIVE INSULATION AND CLAMP CAP

- Immersion insulation according to IEC 60900
- with cross-cut cover

1000V



start from **7,00**
EUR



	D x L mm		Price
117.4234	10 x 40		7,00 €
117.4241	10 x 100		7,00 €
117.4235	10 x 100		7,00 €
117.4236	15 x 100		7,00 €
117.4242	20 x 100		7,00 €
117.4237	25 x 100		8,00 €
117.4243	30 x 100		8,00 €
117.4238	40 x 100		11,00 €
117.4239	50 x 100		17,00 €
117.4240	60 x 100		19,00 €

117.1784 ... 1795

SLEEVE WITH PROTECTIVE INSULATION WITHOUT CLAMP CAP

- Immersion insulation according to IEC 60900

1000V



start from **2,50**
EUR



	D x L mm		Price
117.1784	2 x 40		2,50 €
117.1785	3 x 40		2,50 €
117.1786	4 x 40		2,50 €
117.1787	5 x 40		4,00 €
117.1788	7 x 40		4,00 €
117.1789	10 x 40		4,00 €
117.1790	15 x 40		5,00 €
117.1791	20 x 40		5,00 €
117.1792	25 x 40		7,00 €
117.1793	30 x 40		7,00 €
117.1794	35 x 40		8,00 €
117.1795	40 x 40		8,00 €

117.4244 ... 4246

METER PROTECTIVE SLEEVE WITH PROTECTIVE INSULATION

- Immersion insulation according to IEC 60900
- Numbering 1, 2 or 3 possible



1000V



4,00 EUR

	Size	D x L mm	⚡	Price
117.4244	#1	12 x 80	1000V	4,00 €
117.4245	#2	12 x 80	1000V	4,00 €
117.4246	#3	12 x 80	1000V	4,00 €

117.4247 ... 4258

PUSH-ON GROMMET WITH PROTECTIVE INSULATION

- Immersion insulation according to IEC 60900



1000V



start from 2,50 EUR

	D x L mm	⚡	Price
117.4247	6 x 40 mm	1000V	2,50 €
117.4248	6 x 60 mm	1000V	2,50 €
117.4249	8 x 40 mm	1000V	2,50 €
117.4250	10 x 30 mm	1000V	2,50 €
117.4251	10 x 40 mm	1000V	4,00 €
117.4252	10 x 60 mm	1000V	4,00 €
117.4253	12 x 90 mm	1000V	4,00 €
117.4254	15 x 110 mm	1000V	5,00 €
117.4255	20 x 110 mm	1000V	7,00 €
117.4256	25 x 110 mm	1000V	7,00 €
117.4257	30 x 110 mm	1000V	8,00 €
117.4258	40 x 110 mm	1000V	9,00 €

117.0164 ... 0165

INSULATING BAG FOR CONNECTOR

- for insulating plugs
- with Velcro fastener and eyelet



start from 38,50 EUR

	L x B mm	Price
117.0164	130 x 210	38,50 €
117.0165	225 x 305	53,00 €



117.0204

LOCKING OUT BAG FOR REMOTE CONTROL

- for shutting off machine remote controls, operating elements and plug connections



117.0203

LOCKING OUT STICKER

- to save the workplace
- for hazardous areas and vehicles
- with Ø 10 mm hole for a padlock



11,50 EUR



117.0218 ... 0221

LOCKING OUT PADLOCK, ORANGE

- for the locking of systems during maintenance work, in the electrical sector, in medicine, in the military, in mining, etc.



start from 62,50 EUR

Interchangeable shackles
Adapt your padlock with our interchangeable shackles:

- Metal or composite material
- Diameter: 4.5 or 6 mm
- Height: 38 or 76 mm or Ø 1.4 mm cable for smaller holes plus fins

Personalisation area
Personalisation area for laser marking (optional).

Ultra-strong composite body
Non-conductive, resistant to UV rays, hydrocarbons and extreme environments.
Height: 54 mm
Width: 46 mm
Thickness: 21 mm
Weight: 80 g

Locking out label

- Locking out warning
- Identification of individual responsible
- Rugged label resistant to abrasion and UV rays
- Set of 6 languages

Security key

- Over 1 million key profiles possible
- Captive key system and cylinder with automatic key return
- Colour insert identical to that of the padlock

	Shackle material	Shackle height mm	Shackle diameter mm	Price
117.0218	Metal	38	4,5	62,50 €
117.0219	Metal	76	4,5	64,50 €
117.0220	Composite	38	4,5	62,50 €
117.0221	Composite	76	4,5	64,50 €

SIGNAGE AND MARKINGS

117.0171

ELECTRIC SHOCK FIRST AID POSTER

- First aid instructions for electric shocks with illustrated examples
- German

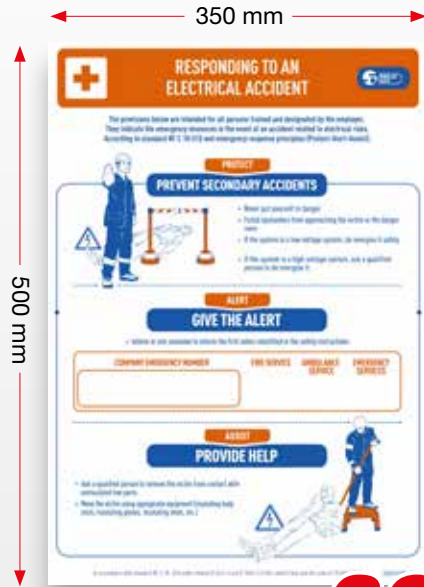

69,00 EUR

117.0172 ... 0174

POSTER

- to illustrate clues
- German

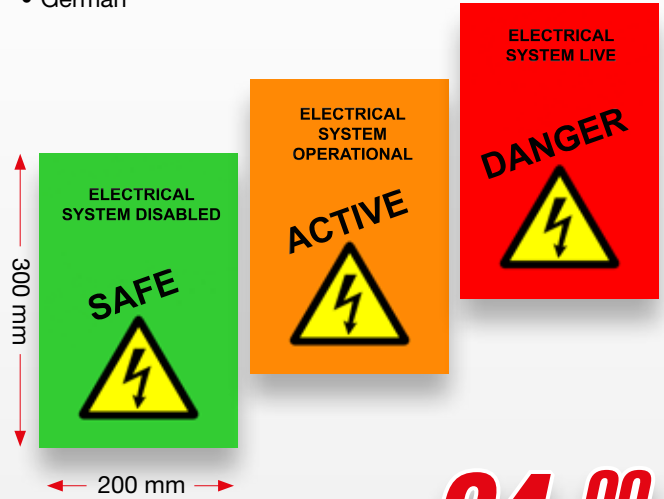

94,00 EUR

	Motiv	Color	L x B mm	VPE	Price
117.0172	secured	green	300 x 200	5	94,00 €
117.0173	active	orange	300 x 200	5	94,00 €
117.0174	danger	red	300 x 200	5	94,00 €

117.0176 ... 0179

HYBRID WARNING SIGN - FLASH FOR WORKING ON HYBRID AND ELECTRIC VEHICLE

- Warning of dangerous voltage
- to save the workplace



start from 11,50 EUR

	Material	Height	Thickness mm	Price
117.0176	Aluminium	100	5	11,50 €
117.0177	Plastic	100	5	12,50 €
117.0178	Aluminium	200	5	44,00 €
117.0179	Plastic	200	5	17,00 €

917.3897

HYBRID WARNING SIGN - SWITCH FOR WORKING ON HYBRID AND ELECTRIC VEHICLES



25,00 EUR

	Diameter	Thickness mm
917.3897	200	5

117.2478 ... 2482

WARNING AND INFORMATION SIGNS



A



B



C



D



E

start from **22,00 EUR**

	Description	B x H x T mm	Price
117.2478	Sign to VDE requirements	A 660 x 1000 x 1,5	128,00 €
117.2479	First Aid sign notice	B 410 x 595 x 1,5	96,00 €
117.2481	Fire-fighting sign	C 410 x 595 x 1,5	96,00 €
117.2483	High-voltage Risk of death sign	D 200 x 237 x 1,5	22,00 €
117.2482	Earthed warning sign	E 200 x 120 x 1,5	50,00 €

117.0175

RECTANGULAR ELECTRICAL NO-ADMISSION ORDER FLAG

- with illustrated example
- with access prohibited



117.0216

WORKING AREA BOUNDARY NO ENTRY

- with note on the workspace limitation
- with 4 eyelets and 2 cords for hanging
- German



46,00 EUR

BARRIERS

117.1545

**SCISSOR BARRIER
MADE OF PLASTIC**

- Ideally suited for closing off danger areas or areas with restricted access
- Secure stand thanks to fillable legs e.g. with sand
- Variably adjustable in width up to 2500 mm
- Folded only 24 cm wide and therefore space-saving to store away

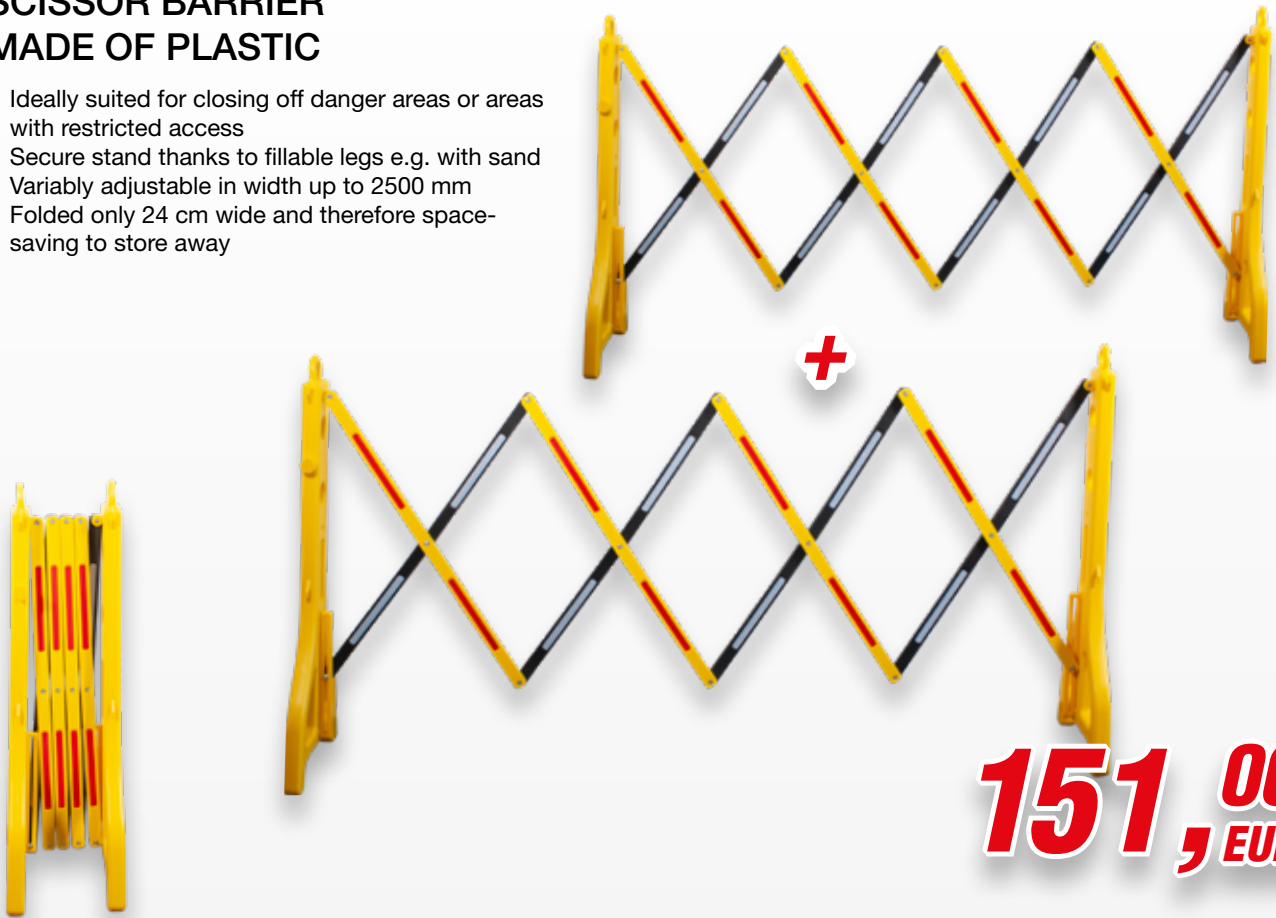

117.1550

SET OF BOLLARDS WITH CHAIN

- Ideal for cordoning off areas with restricted access
- the base can be filled with sand for safe standing
- Barrier post height approx. 850 mm with 4 eyes for hanging the chain
- Including base, hook and 20 m chain
- Made from plastic

75,00
EUR



917.3899

RED/WHITE DIAGONAL STRIPED FOIL BARRIER TAPE

- For safeguarding and indicating hazard areas
- In accordance with ASR A1.3 and BGV A8
- High tear resistance
- Polyethylene



28,00
EUR

RESCUE KITS

117.0026 ... 0027

MOBILE RESCUE KITS

- Quickly accessible rescue kit for mobile rescue operations
- suitable for indoor and outdoor use
- with castors and feet for a better stand
- Handle with telescopic extension

1000V



Description	Price
117.0026 Mobile rescue kit for max 25 KV	1 4.389,00 €
117.0027 Mobile rescue kit for max 36 KV	2 4.447,00 €

start from **4.389,00** EUR



Mobile rescue kit		for max. 25 kV 1	for max. 36 kV 2
Description	Quantity	117.0026	117.0027
Live working boots - Size 45	1 Pair	x	x
Class 3 insulating gloves - Size 10	1 Pair	x	
Class 4 insulating gloves - Size 10	1 Pair		x
Protective case for insulating gloves	1	x	x
Talc container, 50 g	1	x	x
Voltage detector	1	x	x
Telescopic rescue stick without hook	1	x	x
Rescue hook for telescopic insulating stick	1	x	x
Cable shears with protective insulation	1	x	x
Insulating stool	1	x	x
Adhesive barrier tape, black / yellow	1	x	x

117.0119 ... 0124

RESCUE SET FOR LOW VOLTAGE

- Quickly accessible rescue kit for rescue operations
- suitable for indoor and outdoor use
- splash-proof case according to IP54
- with protective gloves, protective cover for gloves, tension tester, rescue rod etc.

1000V

start from **139,50** EUR



Description	Accessories	Price
117.0119	Rescue set for low voltage	2.772,50 €
117.0120	Rescue set for max. 25 kV	3.465,50 €
117.0121	Rescue set for max. 36 kV	3.580,50 €
117.0122	Empty case for rescue kit, small 1	924,00 €
117.0123	Empty case for rescue kit, big 2	1.154,50 €
117.0124	Insert shelf for rescue case 3	138,50 €

Rescue kit for		Low voltage	max. 25 kV	max. 36 kV
Description	Quantity	117.0119	117.0120	117.0121
Live working boots - Size 45	1 Pair		x	x
Class 0 insulating gloves - Size 10	1 Pair	x		
Class 3 insulating gloves - Size 10	1 Pair		x	
Class 4 insulating gloves - Size 10	1 Pair			x
Protective case for insulating gloves	1	x	x	x
Talc container, 50 g	1	x	x	x
Contactless voltage detector	1	x	x	x
Telescopic insulating stick	1	x	x	x
Rescue hook for telescopic insulating stick	1	x	x	x
Insulating mat, Class 0 - 0.6 x 1 m	1	x		
Insulating stool, 36 KV	1		x	x
Adhesive barrier tape, black / yellow	1	x	x	x



150.0913

INSULATED RESCUE ROD, 1680 MM

- insulating rescue rod
- NF EN 60900/IEC 60900/NF EN 6789
- for the rescue of an injured worker in case of electric shock, arc fault etc.
- it is used to pull the victim into a safe area

194,50 EUR

MEASURING AND TESTING EQUIPMENT

Tested safety is important. And that twice. Because who with excitement also needs to know how high they are is. Here come our isolated measurements – and test equipment in play.

The diagnostic tools we will give you on the next present pages, guarantee maximum security and accuracy. This will help you solve any problem on the trail of a very short time.

**ALL FROM THE CHEAP
STANDARD UP TO
HIGH-END MODEL**

**EVERYTHING TO CHECK AND
FOR TROUBLESHOOTING**

**BEST WORKMANSHIP
FOR A LONG SERVICE LIFE**



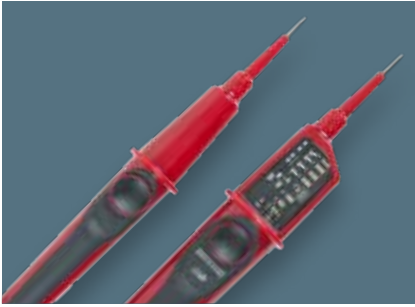

VOLTAGE TESTER

550.1501

POLARITY AND VOLTAGE TESTER WITH PROTECTIVE INSULATION 6 - 400 V

- based on DIN ISO 0680
- for DC and AC voltage
- Probes shielded

1000V



Technical data:	
Readout:	light-emitting diodes/LE
Display level:	6 - 400 V
Power requirement:	140 mA
Allowable duty cycle:	30 s
Frequency range:	0 - 100 Hz
Protection class:	IP40
AC voltage range alternating voltage:	6 - 50 - 120 - 230 - 400 V
DC voltage range direct voltage:	6 - 50 - 120 - 230 - 400 V

26,00
EUR

550.1502

UNIVERSAL VOLTAGE TESTER WITH PROTECTIVE INSULATION 12 - 500 V

- based on DIN ISO 0680
- for DC and AC voltage
- with rotary field and phase display

1000V



Technical data:	
Readout:	light-emitting diodes/LE
Display level:	12 - 500 V
Power requirement:	140 mA
Allowable duty cycle:	30 s
Frequency range:	0 - 100 Hz
Protection class:	IP40
AC voltage range alternating voltage:	12 - 50 - 120 - 150 - 220 - 300 - 400 - 500 V
DC voltage range direct voltage:	12 - 50 - 120 - 150 - 220 - 300 - 400 - 500 V

24,00
EUR

117.1503

VOLTAGE TESTER WITH PROTECTIVE INSULATION, DOUBLE POLE 12 - 1000 V

- tested and approved in accordance with internationally valid standards
- insulated according to IEC IEN 61243-3 (DIN VDE 0682-401)
- DC and AC voltage is indicated by LED
- with vibration alarm



Technical data:	
Readout:	LED/LCD
Display level:	12 - 1000 V
Power requirement:	200 mA
Allowable duty cycle:	30 s
Frequency range:	0 - 500 Hz
Protection class:	IP64
AC voltage range alternating voltage:	12 - 24 - 50 - 120 - 230 - 400 - 690 - 1000 V
DC voltage range direct voltage:	12 - 24 - 50 - 120 - 230 - 400 - 690 - 1000 V

208,00
EUR

117.4266

VOLTAGE TEST BALL WITH PROTECTIVE INSULATION, DOUBLE POLE 50 - 1000 V

- Tested and accredited in accordance with international standard
- Insulated to IEC EN 61243-3 (DIN VDE 0682-401)
- Corresponds to EMC requirements in accordance with DIN EN 61326



Technical data:	
Readout:	LED/LCD
Display level:	50 - 1000 V
Power requirement:	300 mA
Allowable duty cycle:	30 s
Frequency range:	0 - 100 Hz
Protection class:	IP65
AC voltage range alternating voltage:	120 - 200 - 300 - 350 - 400 - 450 - 500 - 550 - 600 - 650 - 700 - 750 - 800 - 850 - 900 - 950 - 1000 V
DC voltage range direct voltage:	120 - 200 - 300 - 350 - 400 - 450 - 500 - 550 - 600 - 650 - 700 - 750 - 800 - 850 - 900 - 950 - 1000 V
Overvoltage category:	CAT IV 600 V CAT III 1000 V
Test voltage:	6 kV

req.

117.0205

TENSION TESTER WITH PROTECTION INSULATION TWO-POLE 12-1000 V

- insulated according to IEC IEN 61243-3 (DIN VDE 0682-401)
- Voltage class CAT IV / 1,000 V
- Probes IP2X protection class
- DC and AC voltage
- with acoustic alarm



266,00
EUR

117.0206

EXTENSION TIPS FOR VOLTAGE TESTERS

- for voltage testers with protective insulation 117.0205 for working on overhead lines and junction boxes
- Glass fibre jacket Ø 10 mm
- Connection probes Ø 4 mm
- Contact tips Ø 4 mm

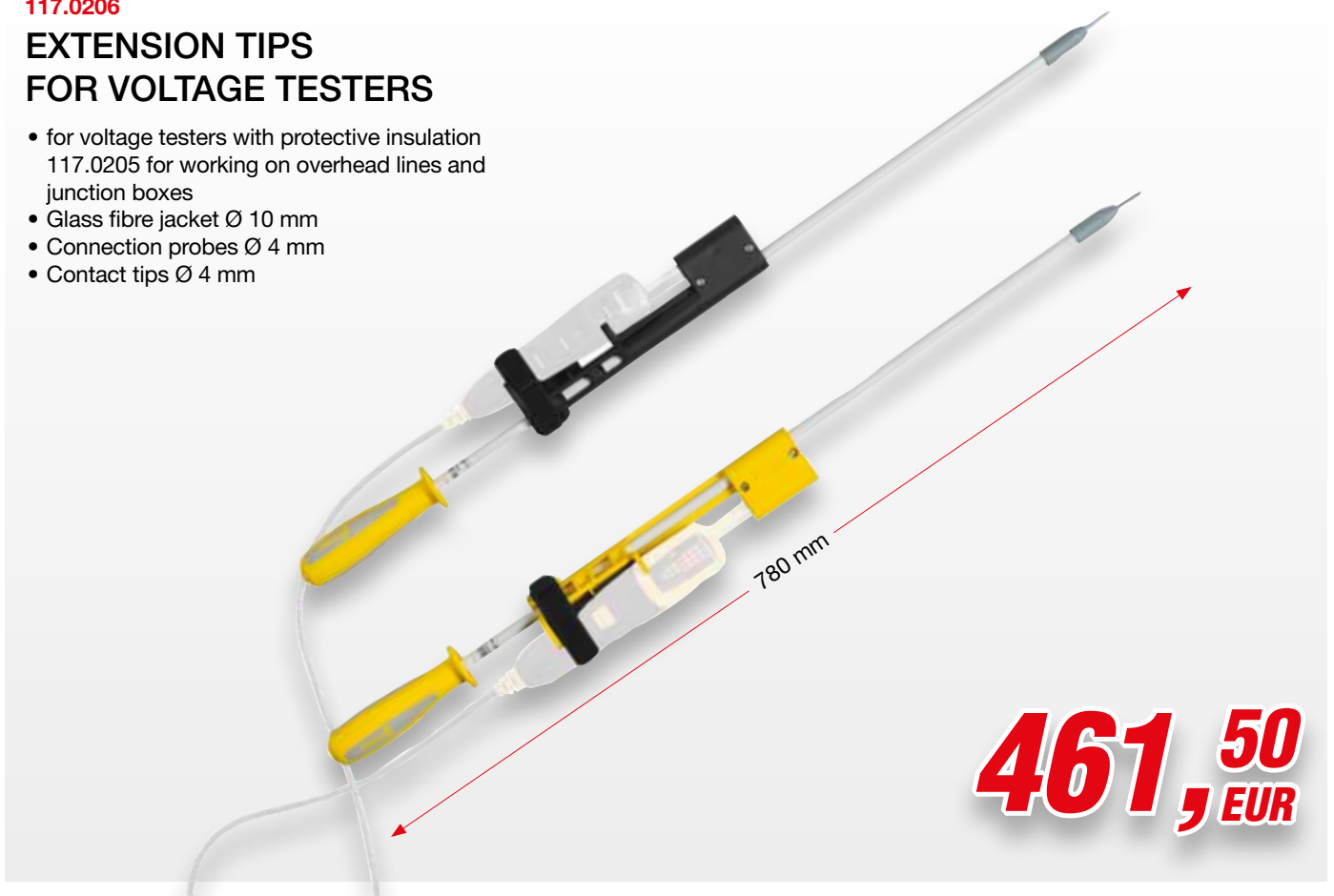

461,50
EUR

150.1670 ... 150.1655

TEST PROBE 6-24V DC WITH 5 M CABLE

- High speed functional testing without removal of components
- Via toggle switches can be plus or minus given to the probe
- Built in bi metal short circuit protection
- No protection wear for troubleshooting
- Version with replaceable probe and alligator clip
- Immediate continuity test of switches, relays, diodes, fuses, wiring harnesses etc.
- For the operation of electronic components, such as relays, fuel pumps, window motors, switches, lamps etc.
- Immediate polarity determination via red/green LED display
- Power can be supplied immediately at the push of a button with the tester
- Built-in bimetallic short circuit fuse (7.5 A), therefore no fuse wear during troubleshooting
- Cable with shielded crocodile clamp and pole terminals
- 5 metre cable length



start from **115,50** EUR

	Application area	Cable length m	Replacement test tip	Price
150.1670	6-24V DC	5	150.1671	115,50 €
150.1655	6-24V DC	25	150.1671	140,50 €

AMPERE PLIERS

150.1745

DIGITAL AMP PLIERS 200 A

- ideal for locating hidden consumers
- ideal to use for DC and AC tests
- from 0.01 A to max. 200 Ampere



Technical data:

Co-current flow:	0,01 - 200 A
DC voltage:	0,1 - 400 V
Alternating current:	0,01 - 200 A
AC voltage:	0,1- 400 V
Resistance measurement:	32 - 32000 ohm
Temperature accuracy:	23° C ± 5° C
Power requirement:	3x 1,5V AAA (not in the delivery)
Storage temperature:	-10° to +60° C (-4° to 140° F)
Working temperature:	-10° to +50° C (14° to 122° F)

554,00
EUR

150.0925

DIGITAL AMP PLIERS 600 A

- ideal to use for AC power testing
- clamp opening 27.0 mm
- measurable conductor diameter 29.0 mm



Technical data:

DC voltage:	600 V
Alternating current:	200 A, 600 A
AC voltage:	600 V
Resistance measurement:	2 megaohm
Temperature accuracy:	23° C ± 5° C
Power requirement:	9V block battery
Storage temperature:	0° to +50° C (14° to 122° F)
Working temperature:	-20° to +60° C (30° to 140° F)

37,50
EUR

150.0929

DIGITAL AMP PLIERS 1000 A

- ideal to use for DC and AC tests
- clamp opening 45.0 mm
- measurable conductor diameter 40.0 mm



Technical data:

Co-current flow:	400 A, 1000 A
DC voltage:	1000 V
Alternating current:	400 A, 1000 A
AC voltage:	700 V
Resistance measurement:	32 megaohm
Capacity measurement:	40 uF
Frequency measurement:	100 kHz
Temperature accuracy:	-40°C / +750°C
Power requirement:	3x 1,5V AAA batteries
Storage temperature:	10° to +50° C (50° to 122° F)
Working temperature:	5° to +35° C (41° to 95° F)

161,50
EUR

MULTIMETER

150.1495

DIGITAL MULTIMETER INCL. TEST PROBES

- with automatic overflow and polarity display
- with safety mechanism for V, μ A / mA / A, therefore incorrect connection impossible
- including test lead set with test probes



Technical data:

Co-current flow:	20 μ A - 10 A
DC voltage:	200 mV - 600 V
AC voltage:	200 V - 600 V
Resistance measurement:	200 Ohm - 2 MOhm
Power requirement:	9V block battery
Fuse protection S1 (fine flow):	250mA/600V; 10A/600V
Storage temperature:	-10° to +50° C (14° to 122° F)
Working temperature:	0° to +40° C (32° to 104° F)

20,00
EUR

150.1480

DIGITAL MULTIMETER, INCLUDING TEST PRODS AND CROCODILE CLAMPS

- with automatic overflow and polarity display
- with safety mechanism for V, μA / mA / A, therefore incorrect connection impossible
- including double set of measuring leads with test probes and crocodile clips



105,00
EUR



Technical data:

Co-current flow:	326 μV - 10A
Capacity measurement:	326 nF - 32,6 μF
DC voltage:	326 mV - 600 V
Alternating current:	326 μV - 10A
AC voltage:	3,26 V - 600 V
Resistance measurement:	326 Ohm - 32,6 MOhm
Frequency measurement:	32,60 - 150kHz
Temperature measurement:	-55°C ~ 1000°C
Power requirement:	9V block battery
Fuse protection S1 (fine flow):	300mA/600V
Fuse protection S2 (power-test socket):	10A/600V
Storage temperature:	-10° to +50° C (14° to 122° F)
Working temperature:	0° to +40° C (32° to 104° F)

150.2040

MULTIMETER WITH INDUCTIVE CLAMP

- with automatic overflow and polarity display
- with safety mechanism for V, μA / mA / A, therefore incorrect connection impossible
- including measuring cable set with test probes, crocodile clips, induction tweezers and temperature probe



req.



Technical data:

Co-current flow:	326 μA - 10 A
Alternating current:	326 μA - 10 A
DC voltage:	326 mV - 1000 V
AC voltage:	3,26 V - 750 V
Resistance measurement:	32 - 32000 ohm
Frequency measurement:	32,60 - 200 kHz
Speed measurement:	300 - 12000 rpm
Temperature accuracy:	23° C \pm 5° C
Power requirement:	9V block battery
Fuse protection S1 (fine flow):	500mA/350V (20x5mm)
Fuse protection S2 (power-test socket):	10A/250V (30x5mm)
Storage temperature:	-10° to +50° C (14° to 122° F)
Working temperature:	0° to +40° C (32° to 104° F)
Temperature measurement:	-20° to +760° C (-4° to 1400° F)

117.0217

DIGITAL MULTIMETER INCL. TEST PROBES

- Specially developed high-quality multimeter with integrated impact protection for hybrid vehicles
- extra safe CATIII (1000V), CATIV (600V)
- with automatic overflow and polarity display
- including test lead set with test probes, crocodile clip and temperature probe



Technical data:	
DC voltage:	400 mV - 600 V
AC voltage:	400 mV - 600 V
Resistance measurement:	400,0 Ohm - 40,0 MOhm
Frequency measurement:	4,000 kHz - 40,00 MHz
Closing angle:	4, 5, 6, 8 Zylinder
Temperature for measurement accuracy:	23° C +/- 5° C
Power supply:	9 V Block-Batterie
Fuse S1 (fine current):	250 V (0,5 A) - 20 x 5 mm
Fuse S2 (current measuring socket):	250 V (20 A) - 32 x 6 mm
Storage temperature:	-10° bis +50° C (14° bis 122° F)
Operating temperature:	0° bis +50° C (32° bis 122° F)
Temperature measurement:	-50° bis +250° C (58° F bis 482° F)

req.

INFRARED THERMOMETER

150.3040

INFRARED-THERMOMETER, -20° TO 500°

- Laser measuring gun for non-contact temperature measurement
- particularly suitable for applications in industrial, construction, automotive, chemical and food monitoring

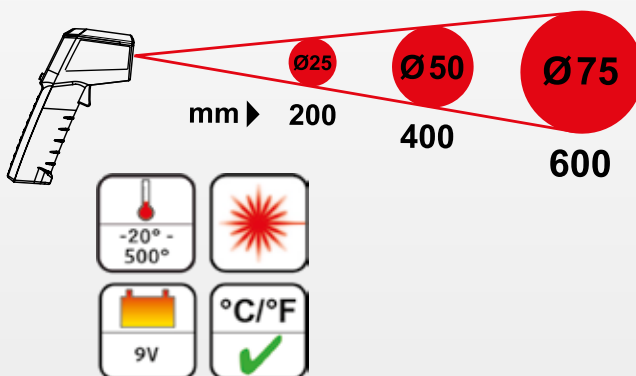

**54,50
EUR**

ISOLATED TOOLS

We make good tools safe: More than 30 years of experience in toolmaking are in every single product of KS TOOLS. On this unique basis of course, we also develop our tools with predictive insulation.

This is where the highest precision meets the best prediction. The millionfold proven socket wrench and torque wrench can be thanks to the Immersion insulation according to IEC 60900 now also for the work on electric and hybrid vehicles as well as for all others High voltage ranges can be used.

SAFETY COMES FIRST

**THE PERFECT TOOL
FOR EVERY APPLICATION**

**HIGHEST PRECISION MEETS
ON THE BEST PREDECTION**





KEYS WITH PREDECTIVE INSULATION





117.1250 ...1254

SLIDING SPANNER WITH PROTECTIVE INSULATION

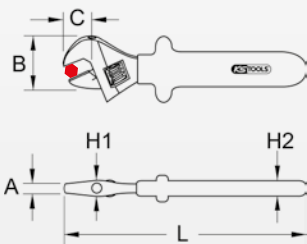
- In accordance to DIN 3117
- Immersion insulation handle to IEC 60900

1000V



	mm	A mm	B mm	C mm	H1 mm	H2 mm	L mm		Price
117.1250	24	12	55	30	8	14	200		70,00 €
117.1253	30	14	77	40	14	19	250		82,50 €
117.1254	34	17,5	78	48	17,5	18	300		138,50 €

start from **70,00** EUR





117.4270 ... 4272

SLIDING SPANNER WITH PROTECTIVE INSULATION

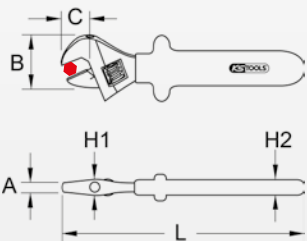
- In accordance to DIN 3117
- Immersion insulation handle to IEC 60900

1000V



	mm	A mm	B mm	C mm	H1 mm	H2 mm	L mm		Price
117.4270	27	13	57,5	20	13	18,5	210		98,00 €
117.4271	31	15	68,5	30	15	20	260		115,50 €
117.4272	34	17,5	79	36	17,5	23	315		157,00 €

start from **98,00** EUR

117.1506 ... 2261

OPEN-END WRENCH WITH PROTECTIVE INSULATION



- In accordance to DIN 7446
- Immersion insulation handle to IEC 60900

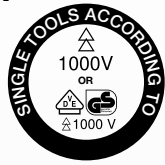

start from **23,00** EUR

	mm	A mm	B mm	L mm	⚡	Price
117.1506	6	12,0	23,5	70,1	1000V	28,00 €
117.1507	7	12,0	25,0	77,0	1000V	28,00 €
117.1508	8	12,5	27,2	84,0	1000V	28,00 €
117.1509	9	12,5	29,2	90,0	1000V	28,00 €
117.1510	10	13,0	31,2	97,0	1000V	32,50 €
117.1511	11	13,4	33,3	104,0	1000V	32,50 €
117.1512	12	13,5	35,2	110,0	1000V	32,50 €
117.1513	13	13,9	37,4	117,0	1000V	32,50 €
117.1514	14	14,2	39,5	124,0	1000V	37,50 €
117.1515	15	14,4	41,2	130,0	1000V	37,50 €
117.1516	16	14,7	42,7	137,0	1000V	39,00 €
117.1517	17	14,9	44,5	144,0	1000V	39,00 €
117.1518	18	15,2	46,7	150,0	1000V	39,00 €
117.1519	19	15,4	48,7	157,0	1000V	39,00 €
117.1522	22	16,2	54,9	174,0	1000V	45,00 €
117.1524	24	16,7	58,4	190,0	1000V	53,00 €
117.1527	27	17,4	63,7	210,0	1000V	70,00 €
117.1530	30	18,1	69,8	230,0	1000V	70,00 €
117.1532	32	18,4	65,8	244,0	1000V	70,00 €
117.2208	5/16"	8,0	17,3	120,0	1000V	23,00 €
117.2209	3/8"	8,8	23,3	108,0	1000V	26,00 €
117.2251	7/16"	9,9	25,6	115,7	1000V	29,00 €
117.2252	1/2"	10,7	30,0	136,0	1000V	29,00 €
117.2253	9/16"	10,6	33,1	145,0	1000V	29,00 €
117.2254	5/8"	10,2	34,4	156,0	1000V	37,50 €
117.2255	11/16"	9,7	38,1	170,0	1000V	37,50 €
117.2256	3/4"	11,1	41,6	173,0	1000V	37,50 €
117.2257	13/16"	12,7	44,8	186,0	1000V	43,00 €
117.2258	7/8"	13,2	49,0	193,0	1000V	43,00 €
117.2259	15/16"	12,7	52,4	215,0	1000V	65,50 €
117.2261	1"	13,2	59,1	210,0	1000V	62,50 €

117.4206 ... 2293

RATCHET RING SPANNER WITH PROTECTIVE INSULATION



- FlankTraction profile
- In accordance to DIN 7446
- Immersion insulation handle to IEC 60900



start from **43,00** EUR

	mm	A mm	B mm	L mm	⚡	Price
117.4206	6	6,7	14,4	126,0	1000V	48,00 €
117.4207	7	6,9	17,2	137,0	1000V	50,00 €
117.4208	8	6,9	17,2	140,0	1000V	48,00 €
117.4209	9	7,3	19,2	150,0	1000V	48,00 €
117.4210	10	7,7	21,2	159,0	1000V	48,00 €
117.4211	11	8,1	22,2	165,0	1000V	48,00 €
117.4212	12	8,6	23,2	172,0	1000V	53,00 €
117.4213	13	9,0	25,2	178,0	1000V	53,00 €
117.4214	14	9,4	28,2	191,0	1000V	53,00 €
117.4215	15	9,8	29,2	200,0	1000V	53,00 €
117.4216	16	10,3	31,2	208,0	1000V	53,00 €
117.4217	17	10,7	32,2	226,0	1000V	53,00 €
117.4218	18	11,1	33,2	237,0	1000V	56,50 €
117.4219	19	11,6	34,2	248,0	1000V	56,50 €
117.4221	21	13,4	40,4	274,0	1000V	50,00 €
117.4222	22	13,4	40,4	290,0	1000V	62,50 €
117.4224	24	14,9	46,4	323,0	1000V	62,50 €
117.4227	27	15,9	52,4	331,0	1000V	72,00 €
117.4228	30	17,4	59,2	389,0	1000V	72,00 €
117.4229	32	17,9	62,4	415,0	1000V	78,00 €
117.4230	34	17,9	62,4	460,0	1000V	91,50 €
117.2283	5/16"	9,2	18,2	124,0	1000V	43,00 €
117.2284	3/8"	11,2	22,9	141,0	1000V	43,00 €
117.2285	7/16"	11,5	24,4	143,8	1000V	43,00 €
117.2286	1/2"	12,9	27,7	150,0	1000V	46,00 €
117.2287	9/16"	12,2	29,8	164,0	1000V	46,00 €
117.2288	5/8"	13,2	33,9	177,0	1000V	46,00 €
117.2289	11/16"	12,9	34,3	185,0	1000V	46,00 €
117.2291	3/4"	13,7	36,8	205,0	1000V	56,50 €
117.2292	7/8"	16,2	44,2	248,0	1000V	72,00 €
117.2293	15/16"	14,0	50,3	277,0	1000V	78,00 €

117.1306 ... 2282

RING SPANNER WITH PROTECTIVE INSULATION, CRANKED



- FlankTraction profile
- In accordance to DIN 7447
- Immersion insulation handle to IEC 60900

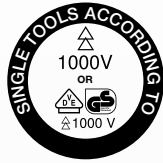

start from **29,00 EUR**

	mm	A mm	B mm	L mm	⚡	Price
117.1306	6	6,1	13,6	160,0	1000V	37,50 €
117.1307	7	6,7	12,6	160,0	1000V	37,50 €
117.1308	8	7,1	14,0	170,0	1000V	37,50 €
117.1309	9	7,4	15,5	170,0	1000V	37,50 €
117.1310	10	7,8	17,0	170,0	1000V	37,50 €
117.1311	11	8,1	18,4	180,0	1000V	37,50 €
117.1312	12	10,2	19,9	190,0	1000V	37,50 €
117.1313	13	10,9	21,3	190,0	1000V	53,00 €
117.1314	14	11,3	22,8	210,0	1000V	53,00 €
117.1315	15	11,9	24,1	215,0	1000V	53,00 €
117.1316	16	12,2	25,7	220,0	1000V	56,50 €
117.1317	17	12,6	27,1	225,0	1000V	56,50 €
117.1318	18	13,2	28,6	230,0	1000V	56,50 €
117.1319	19	13,6	30,1	240,0	1000V	61,50 €
117.1322	22	13,9	34,4	260,0	1000V	61,50 €
117.1324	24	15,4	36,2	280,0	1000V	73,00 €
117.1327	27	16,4	40,4	295,0	1000V	77,00 €
117.1330	30	17,4	44,4	310,0	1000V	94,00 €
117.1332	32	18,4	47,4	330,0	1000V	94,00 €
117.2269	5/16"	7,9	16,6	155,0	1000V	29,00 €
117.2271	3/8"	7,7	16,6	173,0	1000V	29,00 €
117.2272	7/16"	10,5	20,3	175,0	1000V	29,00 €
117.2273	1/2"	10,3	21,7	195,0	1000V	43,00 €
117.2274	9/16"	10,8	24,5	202,0	1000V	43,00 €
117.2275	5/8"	11,9	27,2	210,0	1000V	46,00 €
117.2276	11/16"	12,7	28,4	216,0	1000V	46,00 €
117.2277	3/4"	13,9	31,0	235,0	1000V	46,00 €
117.2278	13/16"	12,5	32,0	255,0	1000V	56,50 €
117.2279	7/8"	15,3	36,0	255,0	1000V	56,50 €
117.2281	15/16"	15,2	38,5	280,0	1000V	62,50 €
117.2282	1"	15,1	42,3	280,0	1000V	72,00 €

117.2262 ... 2268

RATCHET OPEN-END WRENCH WITH PROTECTIVE INSULATION



- In accordance to DIN 3113 / ISO 3318
- Immersion insulation handle to IEC 60900

1000V

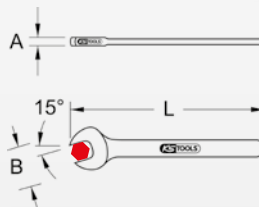

start from **56,50 EUR**

	mm	A mm	B mm	L mm	⚡	Price
117.2262	10	7,1	22,7	105,0	1000V	56,50 €
117.2263	11	8,2	25,6	115,0	1000V	56,50 €
117.2264	12	7,7	27,1	127,0	1000V	56,50 €
117.2265	13	8,5	28,9	135,0	1000V	56,50 €
117.2266	14	9,3	31,8	145,0	1000V	62,50 €
117.2267	17	10,7	38,4	160,0	1000V	70,00 €
117.2268	19	11,8	42,1	175,0	1000V	78,00 €

117.1420

1/4" BIT HOLDER WITH PROTECTIVE INSULATION, 40 MM



- Immersion insulation handle to IEC 60900
- Internal square drive to DIN 3120 / ISO 1174 with ball reception
- Magnetic
- For bits to DIN 3126 / C 6,3

1000V



37,50 EUR

	□	⬡	D1 mm	D2 mm	L mm	⚡	Price
117.1420	1/4"	1/4"	16	16,5	40	1000V	37,50 €

117.1177 ... 1247

SOCKET SCREWDRIVER WITH PROTECTIVE INSULATION

- 6 point
- In accordance to DIN 7445
- Insulated to IEC 60900

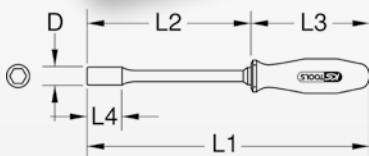

start from **23,00** EUR

	mm	D mm	L1 mm	L2 mm	L3 mm	L4 mm	⚡	Price
117.1177	3	10	215	125	90	37	1000V	28,00 €
117.1178	3,5	10	215	125	90	37	1000V	28,00 €
117.1179	4	10	215	125	90	37	1000V	28,00 €
117.1181	4,5	10	215	125	90	37	1000V	28,00 €
117.1235	5	11,5	215	125	90	37	GS 1000V	23,00 €
117.1182	5,5	15,5	215	125	90	37	GS 1000V	28,00 €
117.1236	6	12,5	215	125	90	37	GS 1000V	23,00 €
117.1237	7	14,5	225	125	100	37	GS 1000V	23,00 €

	mm	D mm	L1 mm	L2 mm	L3 mm	L4 mm	⚡	Price
117.1238	8	15,5	225	125	100	37	GS 1000V	23,00 €
117.1239	9	16,5	225	125	100	37	GS 1000V	25,00 €
117.1240	10	17	225	125	100	37	GS 1000V	28,00 €
117.1241	11	19,5	235	125	110	37	GS 1000V	28,00 €
117.1242	12	20,5	235	125	110	37	GS 1000V	32,50 €
117.1243	13	21,5	235	125	110	37	GS 1000V	35,50 €
117.1244	14	23,5	235	125	110	37	GS 1000V	38,50 €
117.1247	17	26,5	235	125	110	37	GS 1000V	45,00 €

118.1500

OPEN-ENDED WRENCH SET WITH PROTECTIVE INSULATION

- Insulated to IEC 60900
- Jaw 15° offset



356,50 EUR

Size mm
118.1500 7 - 8 - 9 - 10 - 11 - 12 - 13 - 14 - 15 - 16 - 17 - 18 - 19 - 20 - 21 - 22 - 23 - 24

1/4" TOOLS WITH PREDECTIVE INSULATION

117.1400 ... 1402

1/4" MINI TORQUE WRENCH WITH PROTECTIVE INSULATION AND REVERSIBLE RATCHET HEAD

- Immersion insulation according to IEC 60900
- Trigger accuracy: ±4% tolerance of the set scale value and better
- Square drive according to DIN 3120 / ISO 1174 with ball lock
- including calibration declaration of conformity according to DIN EN ISO 6789:2017(E) - traceable to national standards

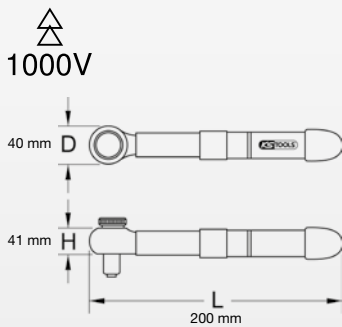

704,50 EUR

	■	Nm	⚡	Price
117.1400	1/4"	2-10	1000V	704,50 €
117.1402	1/4"	5-25	1000V	704,50 €

117.1401

1/4" REVERSIBLE RATCHET WITH PROTECTIVE INSULATION

- Immersion insulation according to IEC 60900
- Square drive according to DIN 3120 / 1174 with ball lock
- with switchable 32-tooth ratchet head



231,50 EUR

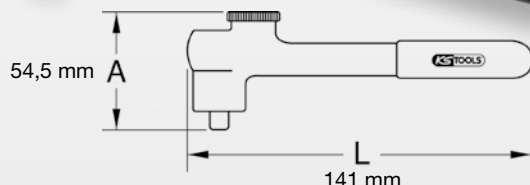

117.1451 ... 1454

1/4" EXTENSION WITH PROTECTIVE INSULATION

- In accordance to DIN 7434
- Immersion insulation handle to IEC 60900
- Square drive adaptor to DIN 3120 / ISO 1174 with ball lock



37,50 EUR



	■	L mm	⚡	Price
117.1451	1/4"	50	1000V	37,50 €
117.1452	1/4"	75	1000V	37,50 €
117.1453	1/4"	100	1000V	37,50 €
117.1454	1/4"	150	1000V	37,50 €

117.1404 ... 1414

1/4" SOCKET WITH PROTECTIVE INSULATION

- 6 point
- based on DIN 7448
- Immersion insulation according to IEC 60900
- Internal square drive according to DIN 3120 / ISO 1174 with ball drill groove

1000V

	mm	D1 mm	D2 mm	L mm		Price
117.1404	4	16,0	10,0	37,0		19,00 €
117.1405	5	16,5	11,5	37,0		24,00 €
117.1406	6	16,5	12,0	37,0		24,00 €
117.1407	7	16,5	13,5	37,0		24,00 €
117.1408	8	16,5	15,5	37,0		24,00 €
117.1409	9	16,5	16,5	37,0		24,00 €
117.1410	10	16,5	17,5	37,0		24,00 €
117.1411	11	16,5	20,0	37,0		24,00 €
117.1412	12	16,5	21,0	37,0		24,00 €
117.1413	13	16,5	22,0	37,0		28,00 €
117.1414	14	16,5	24,0	37,0		28,00 €

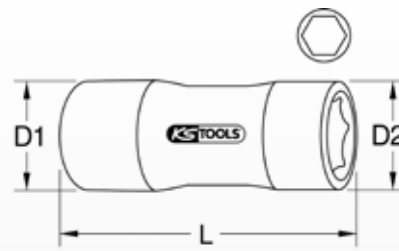

start from **19,00** EUR

117.2401 ... 2407

1/4" SOCKET WITH PROTECTIVE INSULATION

- 6 point
- based on DIN 7448
- Immersion insulation according to IEC 60900
- Internal square drive according to DIN 3120 / ISO 1174 with ball drill groove

1000V

		D1 mm	D2 mm	L mm		Price
117.2401	3/16"	16,5	11,7	38,0		19,00 €
117.2402	1/4"	16,5	13,0	38,0		19,00 €
117.2403	5/16"	16,5	15,1	38,0		19,00 €
117.2404	3/8"	16,5	17,8	38,0		19,00 €
117.2405	7/16"	16,5	19,8	38,0		19,00 €
117.2406	1/2"	16,5	21,6	38,0		19,00 €
117.2407	9/16"	16,5	24,0	38,0		19,00 €

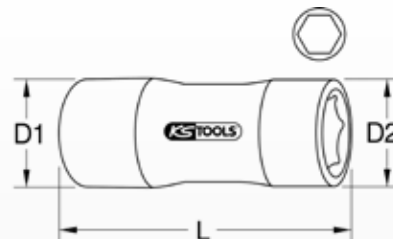









19,00 EUR

117.2341 ... 2352

1/4" SOCKET WITH PROTECTIVE INSULATION, LONG

- 6 point
- based on DIN 7448
- Immersion insulation according to IEC 60900
- Internal square drive according to DIN 3120 / ISO 1174 with ball drill groove

 1000V

	 mm	D1 mm	D2 mm	L mm		Price
117.2341	4	16,5	9,5	55,0		26,00 €
117.2342	5	16,5	10,5	55,0		26,00 €
117.2343	6	16,5	12,5	55,0		26,00 €
117.2344	7	16,5	13,5	55,0		26,00 €
117.2345	8	16,5	16,5	55,0		26,00 €
117.2346	9	16,5	16,5	55,0		26,00 €
117.2347	10	16,5	18,5	55,0		26,00 €
117.2348	11	16,5	19,5	55,0		26,00 €
117.2349	12	16,5	21,5	55,0		26,00 €
117.2351	13	16,5	21,5	55,0		26,00 €
117.2352	14	16,5	21,5	55,0		26,00 €

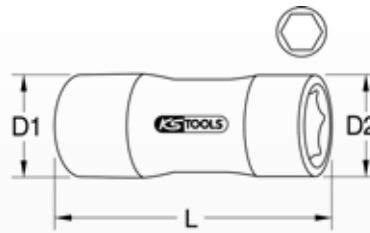







26,00
EUR

117.1415 ... 1419

1/4" BIT SOCKET WITH PROTECTIVE INSULATION FOR HEXAGON SOCKET SCREWS

- Hexagonal
- based on DIN 7448
- Immersion insulation according to IEC 60900
- Internal square drive according to DIN 3120 / ISO 1174 with ball drill groove

 1000V

	 mm	D mm	L mm		Price
117.1415	3	16,5	44,0		28,00 €
117.1416	4	16,5	44,0		28,00 €
117.1417	5	16,5	44,0		28,00 €
117.1418	6	16,5	44,0		28,00 €
117.1419	8	16,5	44,0		28,00 €

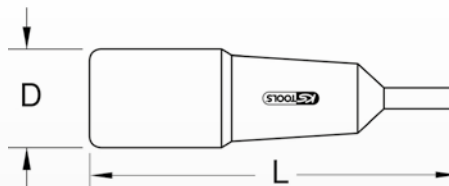

28,00
EUR

117.2471 ... 2477

1/4" BIT SOCKET WITH PROTECTIVE INSULATION FOR TORX SCREWS

- Torx
- based on DIN 7448
- Immersion insulation according to IEC 60900
- Internal square drive according to DIN 3120 / ISO 1174 with ball drill groove

1000V

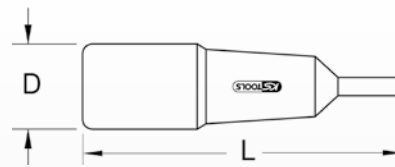

		D mm	L mm		Price
117.2471	T8	15,0	45,0		23,00 €
117.2472	T10	15,0	45,0		23,00 €
117.2473	T15	15,0	45,0		23,00 €
117.2474	T20	15,0	45,0		23,00 €
117.2475	T25	15,0	45,0		23,00 €
117.2476	T27	15,0	45,0		23,00 €
117.2477	T30	15,0	45,0		23,00 €



23,00
EUR

3/8" TOOLS WITH PREDECTIVE INSULATION

117.3922

3/8" FIXED TORQUE WRENCH WITH PROTECTIVE INSULATION

- Immersion insulation according to IEC 60900
- Square drive according to DIN 3120 / 1174 with ball lock
- with switchable 32-tooth ratchet head

1000V

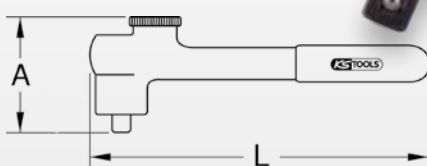

		Nm	A mm	L mm		Price
117.3922	3/8"	5 - 35	78,0	210,0		425,00 €



425,00
EUR

117.1184

3/8" MINI TORQUE WRENCH WITH PROTECTIVE INSULATION AND REVERSIBLE RATCHET HEAD

- Immersion insulation according to IEC 60900
- Trigger accuracy: $\pm 4\%$ tolerance of the set scale value and better
- Square drive according to DIN 3120 / ISO 1174 with ball lock
- including calibration declaration of conformity according to DIN EN ISO 6789:2017(E) - traceable to national standards

1000V

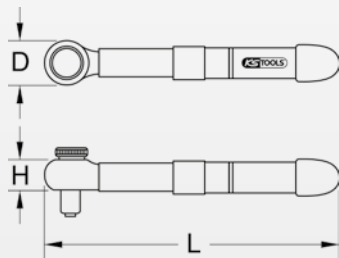

623,50
EUR



	■	Nm	D mm	H mm	L mm	⚡	Price
117.1184	3/8"	5 - 25	40,0	42,0	200,0		623,50 €

117.3805 ... 3810

3/8" TORQUE WRENCH WITH PROTECTIVE INSULATION AND REVERSIBLE RATCHET HEAD



- Immersion insulation according to IEC 60900
- Trigger accuracy: $\pm 4\%$ tolerance of the set scale value and better
- Square drive according to DIN 3120 / ISO 1174 with ball lock
- including calibration declaration of conformity according to DIN EN ISO 6789:2017(E) - traceable to national standards

1000V



start from **682,00**
EUR



	■	Nm	H mm	L mm	⚡	Price
117.3805	3/8"	5 - 25	51,0	280,0		682,00 €
117.3810	3/8"	5 - 50	51,0	370,0		704,50 €

117.3801

3/8" REVERSIBLE RATCHET WITH PROTECTIVE INSULATION, 32-TOOTH

- Immersion insulation according to IEC 60900
- Square drive according to DIN 3120 / 1174 with ball lock
- with switchable 32-tooth ratchet head

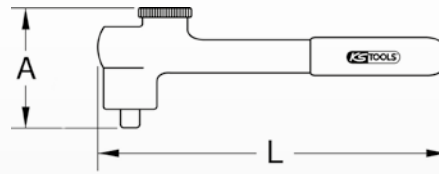

1000V



193,50
EUR

		A mm	L mm		Price
117.3801	3/8"	73,0	200,0		193,50 €

117.3800

3/8" REVERSIBLE RATCHET WITH PROTECTIVE INSULATION, 32-TOOTH

- Immersion insulation according to IEC 60900
- Square drive according to DIN 3120 / 1174 with ball lock
- with switchable 32-tooth ratchet head

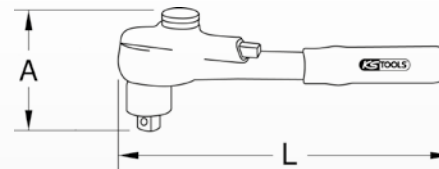

1000 V



273,50
EUR

		A mm	L mm		Price
117.3800	3/8"	78,0	205,0		273,50 €

117.2301 ... 3852

3/8" EXTENSION WITH PROTECTIVE INSULATION

- In accordance to DIN 7434
- Immersion insulation handle to IEC 60900
- Square drive adaptor to DIN 3120 / ISO 1174 with ball lock

1000V



start from **43,00** EUR

	□	L mm	⚡	Price
117.2301	3/8"	75	1000V	43,00 €
117.3851	3/8"	125	1000V	50,00 €
117.3852	3/8"	250	1000V	46,00 €

117.3823 ... 3825

3/8" EXTENSION WITH PROTECTIVE INSULATION AND SCREW LOCKING

- In accordance to DIN 7434
- Immersion insulation handle to IEC 60900
- Square drive adaptor to DIN 3120 / ISO 1174 with ball lock

1000V



193,50 EUR

	□	L mm	⚡	Price
117.3823	3/8"	125	1000V	193,50 €
117.3825	3/8"	250	1000V	193,50 €

117.3811 ... 3812

3/8" BIT HOLDER WITH PROTECTIVE INSULATION

- Immersion insulation handle to IEC 60900
- Internal square drive to DIN 3120 / ISO 1174 with ball reception
- Magnetic
- For bits to DIN 3126 / C 6,3

1000V

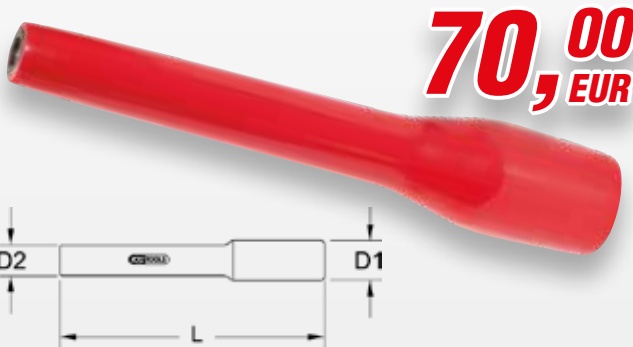

70,00 EUR

	□	⬡	D1 mm	D2 mm	L mm	⚡	Price
117.3811	3/8"	1/4"	25	13	125	1000V	70,00 €
117.3812	3/8"	1/4"	25	13	250	1000V	70,00 €

117.3820

3/8" T-HANDLE SOCKET WRENCH WITH PROTECTIVE INSULATION, 200 MM

- Square drive adaptor to DIN 3120 / 1174 with ball lock
- In accordance to DIN 7436
- Immersion insulation handle to IEC 60900
- With screw adjustment

1000V

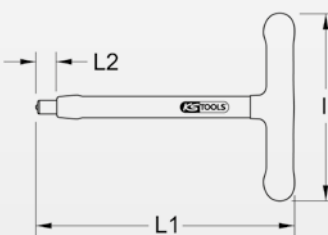

52,00 EUR

	□	I	L1 mm	L2 mm	⚡	Price
117.3820	3/8"	165	200	15	1000V	52,00 €

117.3831 ... 1031

3/8" SOCKET WITH PROTECTIVE INSULATION

- In accordance to DIN 7448
- Insulated handle to IEC 60900
- Internal square drive to DIN 3120 / ISO 1174 with ball reception
- FlankTraction profile
- 12 point

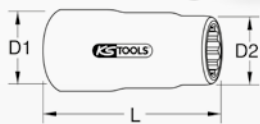
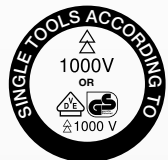

start from **28,00** EUR

	mm	D1 mm	D2 mm	L mm	⚡	Price
117.3831	6	23,0	14,0	48,0	1000V	37,50 €
117.3832	7	23,0	15,0	48,0	1000V	37,50 €
117.3833	8	23,0	16,0	48,0	1000V	37,50 €
117.3834	9	23,0	17,0	48,0	1000V	37,50 €
117.3835	10	23,0	19,5	48,0	1000V	37,50 €
117.3836	11	23,0	19,5	48,0	1000V	37,50 €
117.3837	12	23,0	20,5	48,0	1000V	37,50 €
117.3838	13	23,0	23,0	48,0	1000V	36,50 €
117.3839	14	23,0	23,5	48,0	1000V	36,50 €
117.3840	15	23,0	26,0	48,0	1000V	37,50 €
117.3841	16	23,0	26,5	48,0	1000V	37,50 €
117.3842	17	23,0	28,0	48,0	1000V	37,50 €
117.3843	18	23,0	30,0	48,0	1000V	37,50 €
117.3844	19	23,0	30,0	48,0	1000V	37,50 €
117.3845	20	23,0	32,0	48,0	1000V	37,50 €
117.3846	21	23,0	33,5	48,0	1000V	37,50 €
117.3847	22	23,0	37,5	48,0	1000V	39,00 €
117.3813	23	22,5	34,0	48,0	1000V	32,50 €
117.3848	24	23,0	38,5	48,0	1000V	45,00 €
117.1020	1/4"	22,0	13,0	48,0	1000V	33,50 €
117.1021	5/16"	22,0	15,5	48,0	1000V	28,00 €
117.1022	3/8"	22,0	19,0	48,0	1000V	33,50 €
117.1023	7/16"	22,0	20,0	48,0	1000V	28,00 €
117.1024	1/2"	22,0	23,0	48,0	1000V	33,50 €
117.1025	9/16"	22,0	24,5	48,0	1000V	33,50 €
117.1026	5/8"	22,0	26,5	48,0	1000V	33,50 €
117.1027	11/16"	22,0	29,0	48,0	1000V	33,50 €
117.1028	3/4"	22,0	30,0	48,0	1000V	33,50 €
117.1029	13/16"	22,0	32,0	48,0	1000V	36,50 €
117.1030	7/8"	22,0	36,0	48,0	1000V	36,50 €
117.1031	15/16"	22,0	37,0	48,0	1000V	36,50 €

117.1090 ... 3884

3/8" SOCKET WITH PROTECTIVE INSULATION, LONG

- Immersion insulation according to IEC 60900
- Internal square drive according to DIN 3120 / ISO 1174 with ball drill groove
- FlankTraction Profile
- based on DIN 7448

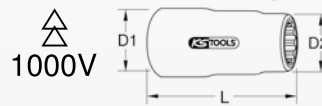

start from **44,00** EUR

	Profil	mm	D1 mm	D2 mm	L mm	⚡	Price
117.1090	10	10	22	18,0	80	1000V	44,00 €
117.1091	11	11	22	19,5	80	1000V	44,00 €
117.1092	12	12	22	21,0	80	1000V	44,00 €
117.1093	13	13	22	23,0	80	1000V	44,00 €
117.1094	14	14	22	24,0	80	1000V	44,00 €
117.1095	15	15	22	26,0	80	1000V	44,00 €
117.1096	16	16	22	27,0	80	1000V	44,00 €
117.1097	17	17	22	28,0	80	1000V	44,00 €
117.3881	18	18	22	29,5	80	1000V	50,00 €
117.3882	19	19	22	30,5	80	1000V	50,00 €
117.3883	22	22	22	34,5	80	1000V	62,50 €
117.3884	24	24	22	37,5	80	1000V	71,00 €

117.3853 ... 3860

3/8" SOCKET WITH PROTECTIVE INSULATION, XL

- Internal square drive to DIN 3120 / ISO 1174 with ball reception
- Immersion insulation handle to IEC 60900
- FlankTraction profile
- 12 point

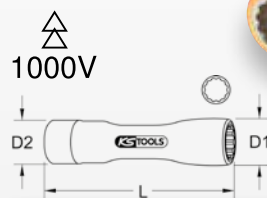

start from **96,00** EUR

	mm	D1 mm	D2 mm	L mm	⚡	Price
117.3853	10	23	19	135	1000V	96,00 €
117.3854	11	23	20	135	1000V	96,00 €
117.3855	12	23	22	135	1000V	96,00 €
117.3856	13	23	22	135	1000V	96,00 €
117.3857	14	23	26	135	1000V	97,00 €
117.3858	17	23	29	135	1000V	104,00 €
117.3859	19	23	31	135	1000V	104,00 €
117.3860	22	23	35	135	1000V	104,00 €

117.2376 ... 2388

3/8" TORX E SOCKET WITH PROTECTIVE INSULATION

- Torx E
- Immersion insulation to IEC 60900
- Internal square drive to DIN 3120 / ISO 1174 with ball reception

1000V

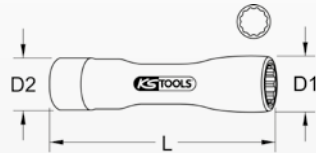

	☆	D1 mm	D2 mm	L mm	⚡	Price
117.2376	E4	23,0	10,8	45,0	1000V	26,00 €
117.2377	E5	23,0	12,3	45,0	1000V	26,00 €
117.2378	E6	23,0	13,5	45,0	1000V	26,00 €
117.2379	E7	23,0	13,7	45,0	1000V	26,00 €
117.2381	E8	23,0	15,5	45,0	1000V	26,00 €
117.2382	E10	23,0	17,2	45,0	1000V	26,00 €
117.2383	E11	23,0	18,0	45,0	1000V	26,00 €
117.2384	E12	23,0	19,0	45,0	1000V	26,00 €
117.2385	E14	23,0	20,5	45,0	1000V	29,00 €
117.2386	E16	23,0	23,1	45,0	1000V	29,00 €
117.2387	E18	23,0	25,0	45,0	1000V	29,00 €
117.2388	E20	23,0	27,0	45,0	1000V	29,00 €



start from **26,00** EUR

117.2363 ... 2375

3/8" TORX E SOCKET WITH PROTECTIVE INSULATION, LONG

- Torx E
- Immersion insulation handle to IEC 60900
- Internal square drive to DIN 3120 / ISO 1174 with ball reception

1000V



	☆	D1 mm	D2 mm	L mm	⚡	Price
117.2363	E4	23,0	9,4	72,0	1000V	56,50 €
117.2364	E5	23,0	10,9	72,0	1000V	56,50 €
117.2365	E6	23,0	12,3	72,0	1000V	56,50 €
117.2366	E7	23,0	13,1	72,0	1000V	56,50 €
117.2367	E8	23,0	14,5	72,0	1000V	56,50 €
117.2368	E10	23,0	16,2	72,0	1000V	56,50 €
117.2369	E11	23,0	17,0	72,0	1000V	56,50 €
117.2371	E12	23,0	18,0	72,0	1000V	56,50 €
117.2372	E14	23,0	20,6	72,0	1000V	56,50 €
117.2373	E16	23,0	23,0	72,0	1000V	56,50 €
117.2374	E18	23,0	24,8	72,0	1000V	122,00 €
117.2375	E20	23,0	26,0	72,0	1000V	req.



start from **56,50** EUR

117.1735 ... 1738

3/8" BIT SOCKET WITH PROTECTIVE INSULATION FOR HEXAGON SOCKET SCREWS

- Hexagon socket
- Immersion insulation handle to IEC 60900
- Internal square drive to DIN 3120 / ISO 1174 with ball reception

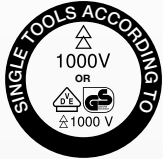

43,00 EUR

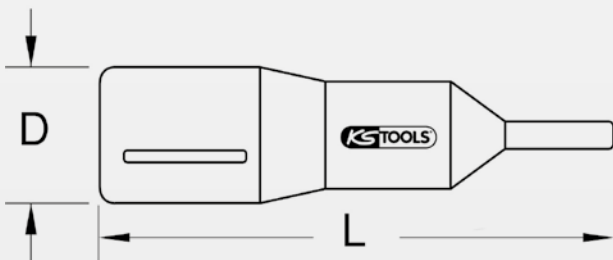

	mm	D mm	L mm	⚡	Price
117.1735	4	22	54	1000V	43,00 €
117.1736	5	22	54	1000V	43,00 €
117.1737	6	22	54	1000V	43,00 €
117.1738	8	22	54	1000V	43,00 €

117.3861 ... 3878

3/8" BIT SOCKET WITH PROTECTIVE INSULATION FOR HEXAGON SOCKET SCREWS

- Hexagonal
- Immersion insulation according to IEC 60900
- Internal square drive according to DIN 3120 / ISO 1174 with ball drill groove

1000V



start from 53,00 EUR

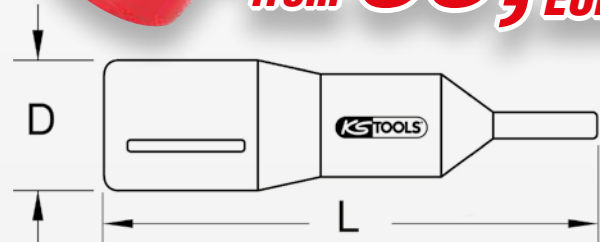

	mm	D mm	L mm	⚡	Price
117.3861	4	23	82	1000V	53,00 €
117.3862	5	23	82	1000V	53,00 €
117.3863	6	23	82	1000V	53,00 €
117.3864	8	23	82	1000V	53,00 €
117.3865	10	23	82	1000V	53,00 €
117.3866	12	23	82	1000V	53,00 €
117.3867	4	23	116	1000V	53,00 €
117.3868	5	23	116	1000V	53,00 €
117.3869	6	23	116	1000V	53,00 €
117.3870	8	23	116	1000V	52,00 €
117.3871	10	23	116	1000V	53,00 €
117.3872	12	23	116	1000V	53,00 €
117.3873	5	23	180	1000V	53,00 €
117.3874	6	23	180	1000V	53,00 €
117.3875	5	23	270	1000V	56,50 €
117.3876	6	23	270	1000V	56,50 €
117.3877	8	23	270	1000V	56,50 €
117.3878	10	23	270	1000V	56,50 €

117.2454 ... 2461

3/8" BIT SOCKET WITH PROTECTIVE INSULATION FOR TORX SCREWS, SHORT

- Torx
- Immersion insulation handle to IEC 60900
- Internal square drive to DIN 3120 / ISO 1174 with ball reception

1000V



43,00
EUR

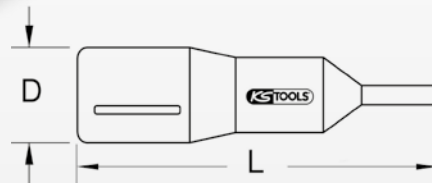

		D mm	L mm		Price
117.2454	T10	20	65		43,00 €
117.2455	T15	20	65		43,00 €
117.2456	T20	20	65		43,00 €
117.2457	T25	20	65		43,00 €
117.2458	T27	20	65		43,00 €
117.2459	T30	20	65		43,00 €
117.2461	T40	20	65		43,00 €



117.2462 ... 2468

3/8" BIT SOCKET WITH PROTECTIVE INSULATION FOR TORX SCREWS, LONG

- Torx
- Immersion insulation handle to IEC 60900
- Internal square drive to DIN 3120 / ISO 1174 with ball reception

1000V



43,00
EUR

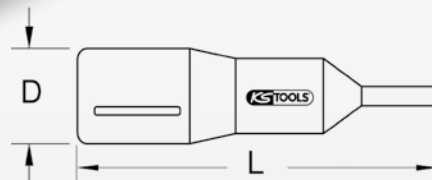

		D mm	L mm		Price
117.2462	T10	20	100		43,00 €
117.2463	T15	20	100		43,00 €
117.2464	T20	20	100		43,00 €
117.2465	T25	20	100		43,00 €
117.2466	T27	20	100		43,00 €
117.2467	T30	20	100		43,00 €
117.2468	T40	20	100		43,00 €



117.3893 ... 3895

3/8" BIT SOCKET WITH PROTECTIVE INSULATION FOR MULTI-TOOTH (XZN®) SCREWS

- Spline (XZN®)
- Immersion insulation handle to IEC 60900
- Internal square drive to DIN 3120 / ISO 1174 with ball reception

1000V



43,00 EUR

		D mm	L mm		Price
117.3893	M8	23	95		43,00 €
117.3894	M10	23	95		43,00 €
117.3895	M12	23	95		43,00 €

117.2313 ... 2314

3/8" BIT HOLDER WITH PROTECTIVE INSULATION

- Immersion insulation handle to IEC 60900
- Internal square drive to DIN 3120 / ISO 1174 with ball reception
- Magnetic
- For bits to DIN 3126 / C 6,3

1000V



43,00 EUR

		mm	D mm	L mm		Price
117.2313	3/8"	1/4"	55	45		43,00 €
117.2314	3/8"	8	55	50		43,00 €

117.1189 ... 3885

REDUCING ADAPTER WITH PROTECTIVE INSULATION

- In accordance to DIN 3123 / ISO 3316
- Insulated handle to IEC 60900
- Square drive adaptor to DIN 3120 / ISO 1174 with ball lock

1000V

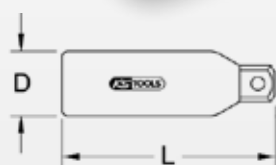

start **32,50** EUR

			D mm	L mm		Price
117.1189	1/4"	3/8"	17	39		32,50 €
117.3885	3/8"	1/2"	23	52		37,50 €

117.1190 ... 1285

REDUCING ADAPTER WITH PROTECTIVE INSULATION

- based on DIN 3123 / ISO 3316
- Immersion insulation according to IEC 60900
- Square drive according to DIN 3120 / ISO 1174 with ball lock

1000V



start **32,50** EUR

			D mm	L mm		Price
117.1190	3/8"	1/4"	22	86		32,50 €
117.1285	1/2"	3/8"	20	75		45,00 €

1/2" TOOLS WITH PROTECTIVE INSULATION

117.1001

1/2" PRE-SET TORQUE LIMITER WITH PROTECTIVE INSULATION, 5 - 35 NM

- Immersion insulation according to IEC 60900
- Trigger accuracy: $\pm 4\%$ tolerance of the set scale value and better
- Without scale - with fixed value
- Square drive according to DIN 3120 / ISO 1174 with ball lock
- including calibration declaration of conformity according to DIN EN ISO 6789:2017(E) - traceable to national standards

1000V



508,50 EUR

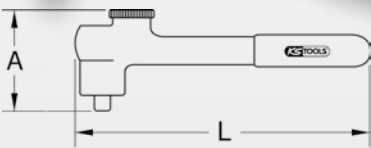

	Nm	A mm	L mm	⚡
117.1001	5 - 35	78	250	1000V

117.1300 ... 1303

1/2" TORQUE WRENCH WITH PROTECTIVE INSULATION AND REVERSIBLE RATCHET HEAD

- Immersion insulation handle to IEC 60900
- Release accuracy: $\pm 4\%$ tolerance from the set scale value and better
- Square drive adaptor to DIN 3120 / ISO 1174 with ball lock
- including calibration declaration of conformity according to DIN EN ISO 6789:2017(E) - traceable to national standards



start from 788,00 EUR



	Nm	H mm	L mm	⚡	Price
117.1301	5-25	61	280	1000V	819,00 €
117.1300	5-50	61	370	1000V	788,00 €
117.1302	20-100	61	460	1000V	803,50 €
117.1303	40-220	61	530	1000V	878,00 €

117.1201

1/2" HEAD-REVERSIBLE RATCHET WITH PROTECTIVE INSULATION, 32 TOOTH

- Square drive adaptor to DIN 3120 / 1174 with ball lock
- In accordance to DIN 7449
- Immersion insulation handle to IEC 60900
- With reversible 32-teeth ratchet head

	Nm	A mm	L mm	⚡
117.1201	5 - 35	90	245	1000V

1000V

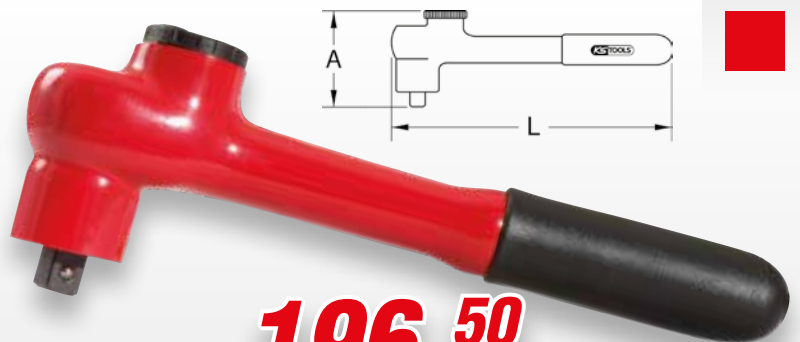

196,50 EUR

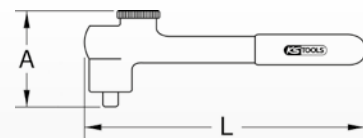

117.1200

1/2" HEAD-REVERSIBLE RATCHET WITH PROTECTIVE INSULATION, 32 TOOTH

- Square drive adaptor to DIN3120 / ISO 1174 with ball lock
- In accordance to DIN 7449
- Immersion insulation handle to IEC 60900
- With reversible 32-teeth ratchet head

	■	A mm	L mm	⚡
117.1200	1/2"	88	245	1000 V

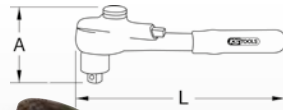

277,50
EUR



117.2302 ... 1252

1/2" EXTENSION WITH PROTECTIVE INSULATION

- In accordance to DIN 7434
- Immersion insulation handle to IEC 60900
- Square drive adaptor to DIN 3120 / ISO 1174 with ball lock

	■	L mm	⚡	Price
117.2302	1/2"	75	1000V	39,50 €
117.1251	1/2"	125	1000V	50,00 €
117.1252	1/2"	250	1000V	52,00 €

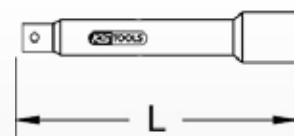

start from 39,50
EUR



117.1202 ... 1203

1/2" EXTENSION WITH PROTECTIVE INSULATION AND SCREW ADJUSTMENT

- In accordance to DIN 7434
- Immersion insulation handle to IEC 60900
- Square drive adaptor to DIN 3120 / ISO 1174 with ball lock

	■	L mm	⚡	Price
117.1202	1/2"	125	1000V	65,50 €
117.1203	1/2"	250	1000V	75,00 €

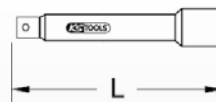

start from 65,50
EUR



117.1229 ... 1231

1/2" EXTENSION WITH PROTECTIVE INSULATION

- In accordance to DIN 7434
- Immersion insulation handle to IEC 60900
- Square drive adaptor to DIN 3120 / ISO 1174 with ball lock

	■	L mm	⚡	Price
117.1229	1/2"	125	1000V	196,50 €
117.1231	1/2"	250	1000V	203,00 €

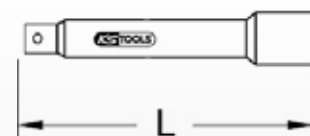

start from 196,50
EUR



117.1208 ... 1232

1/2" SOCKET WITH PROTECTIVE INSULATION

- 6 point
- In accordance to DIN 7448
- Immersion insulation handle to IEC 60900
- Internal square drive to DIN 3120 / ISO 1174 with ball reception

1000V

start from **28,00** EUR

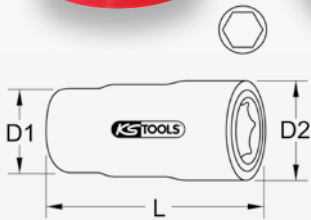

	mm	D1 mm	D2 mm	L mm	⚡	Price
117.1208	8	26,0	17,0	55,0	1000V	28,00 €
117.1209	9	26,0	19,0	55,0	1000V	28,00 €
117.1210	10	26,0	20,0	55,0	1000V	28,00 €
117.1211	11	26,0	21,0	55,0	1000V	28,00 €
117.1212	12	26,0	22,0	55,0	1000V	30,00 €
117.1213	13	26,0	23,5	55,0	1000V	30,00 €
117.1214	14	26,0	25,0	55,0	1000V	30,00 €
117.1215	15	26,0	26,0	55,0	1000V	30,00 €
117.1216	16	26,0	26,5	55,0	1000V	30,00 €
117.1217	17	26,0	28,5	55,0	1000V	30,00 €
117.1218	18	26,0	31,0	55,0	1000V	30,00 €
117.1219	19	26,0	31,5	55,0	1000V	35,50 €
117.1220	20	26,0	33,0	55,0	1000V	37,50 €
117.1221	21	26,0	34,5	55,0	1000V	37,50 €
117.1222	22	26,0	35,0	55,0	1000V	37,50 €
117.1223	23	26,0	36,0	55,0	1000V	37,50 €
117.1224	24	26,0	37,0	55,0	1000V	39,50 €
117.1226	26	26,0	39,0	61,0	1000V	39,00 €
117.1227	27	26,0	41,0	61,0	1000V	44,00 €
117.1228	28	26,0	44,0	61,0	1000V	45,00 €
117.1230	30	26,0	46,0	61,0	1000V	39,00 €
117.1232	32	26,0	49,5	61,0	1000V	38,50 €

117.1333 ... 1350

1/2" SOCKET WITH PROTECTIVE INSULATION, LONG

- 6 point
- In accordance to DIN 7448
- Immersion insulation handle to IEC 60900
- Internal square drive to DIN 3120 / ISO 1174 with ball reception

1000V



start from **70,00** EUR

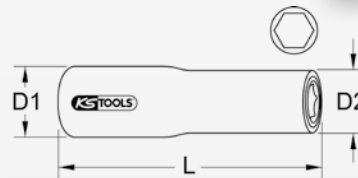

	mm	D1 mm	D2 mm	L mm	⚡	Price
117.1333	8	26,0	19,0	94,0	1000V	70,00 €
117.1334	10	26,0	21,0	94,0	1000V	70,00 €
117.1335	11	26,0	21,0	94,0	1000V	70,00 €
117.1336	12	26,0	22,0	94,0	1000V	71,00 €
117.1337	13	26,0	23,5	94,0	1000V	70,00 €
117.1338	14	26,0	25,5	94,0	1000V	70,00 €
117.1339	15	26,0	27,0	94,0	1000V	70,00 €
117.1340	16	26,0	28,0	94,0	1000V	70,00 €
117.1341	17	26,0	29,0	94,0	1000V	70,00 €
117.1342	18	26,0	30,0	94,0	1000V	70,00 €
117.1343	19	26,0	30,5	94,0	1000V	70,00 €
117.1344	21	26,0	35,0	94,0	1000V	70,00 €
117.1345	22	26,0	35,5	94,0	1000V	77,00 €
117.1346	23	26,0	36,0	94,0	1000V	77,00 €
117.1347	24	26,0	39,0	94,0	1000V	77,00 €
117.1348	27	26,0	42,0	94,0	1000V	88,50 €
117.1349	30	26,0	46,5	94,0	1000V	104,00 €
117.1350	32	26,0	48,5	94,0	1000V	104,00 €

117.1205

1/2" T-HANDLE SOCKET SPANNER WITH PROTECTIVE INSULATION AND SCREW ADJUSTMENT

- Square drive adaptor to DIN 3120 / 1174 with ball lock
- In accordance to DIN 7436
- Immersion insulation handle to IEC 60900

1000V

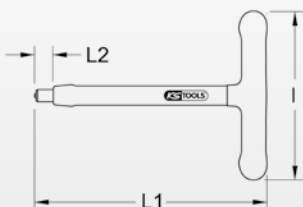

55,50 EUR

		I	L1 mm	L2 mm		Price
117.1205	1/2"	165	200	15		55,50 €

117.1371 ... 1379

1/2" SOCKET WITH PROTECTIVE INSULATION, XL

- 6 point
- In accordance to DIN 7448
- Immersion insulation handle to IEC 60900
- Internal square drive to DIN 3120 / ISO 1174 with ball reception

1000V

97,00 EUR

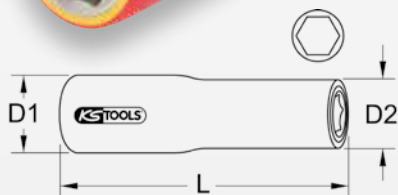

		D1 mm	D2 mm	L mm		Price
117.1371	13	26,0	23,5	145,0		97,00 €
117.1372	14	26,0	25,5	145,0		97,00 €
117.1373	17	26,0	29,0	145,0		97,00 €
117.1374	19	26,0	30,5	145,0		97,00 €
117.1375	22	26,0	35,5	145,0		97,00 €
117.1376	24	26,0	29,0	145,0		97,00 €
117.1377	27	26,0	42,0	145,0		97,00 €
117.1378	30	26,0	46,5	145,0		97,00 €
117.1379	32	26,0	48,5	145,0		97,00 €

117.1381 ... 1389

1/2" SOCKET WITH PROTECTIVE INSULATION, XL

- 6 point
- In accordance to DIN 7448
- Immersion insulation handle to IEC 60900
- Internal square drive to DIN 3120 / ISO 1174 with ball reception

1000V

96,00 EUR

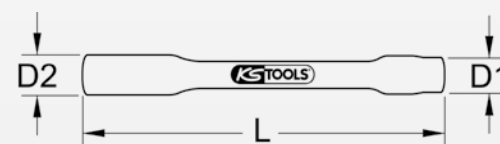

		D1 mm	D2 mm	L mm		Price
117.1381	13	26,0	23,5	255,0		97,00 €
117.1382	14	26,0	25,5	255,0		97,00 €
117.1383	17	26,0	29,0	255,0		97,00 €
117.1384	19	26,0	30,5	255,0		97,00 €
117.1385	22	26,0	35,5	255,0		96,00 €
117.1386	24	26,0	39,0	255,0		96,00 €
117.1387	27	26,0	42,0	255,0		96,00 €
117.1388	30	26,0	46,5	255,0		97,00 €
117.1389	32	26,0	48,5	255,0		97,00 €

117.1351 ... 1367

1/2" SOCKET WITH PROTECTIVE INSULATION



- 12 point
- FlankTraction profile
- In accordance to DIN 7448
- Immersion insulation handle to IEC 60900
- Internal square drive to DIN 3120 / ISO 1174 with ball reception

1000V

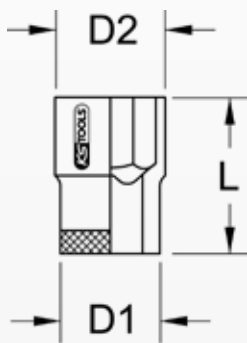

start from **28,00** EUR

		D1 mm	D2 mm	L mm		Price
117.1351	5/16"	26,0	18,0	55,0		28,00 €
117.1352	3/8"	26,0	19,5	55,0		28,00 €
117.1353	7/16"	26,0	21,0	55,0		28,00 €
117.1354	15/32"	26,0	21,5	55,0		28,00 €
117.1355	1/2"	26,0	24,5	55,0		28,00 €
117.1356	9/16"	26,0	25,0	55,0		28,00 €
117.1357	5/8"	26,0	26,5	55,0		28,00 €
117.1358	11/16"	26,0	29,0	55,0		28,00 €
117.1361	3/4"	26,0	30,0	55,0		28,00 €
117.1359	25/32"	26,0	29,5	55,0		32,50 €
117.1363	7/8"	26,0	35,5	59,0		32,50 €
117.1364	15/16"	26,0	38,0	59,0		37,50 €
117.1368	1"	26,0	39,5	59,0		39,00 €
117.1369	1.1/8"	26,0	45,0	59,0		39,00 €
117.1367	1.1/4"	26,0	49,0	59,0		39,00 €

117.2353 ... 2362

1/2" TORX E-SOCKET WITH PROTECTIVE INSULATION







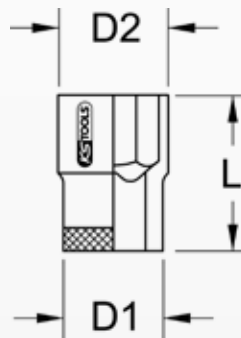



- Torx E
- Immersion insulation handle to IEC 60900
- Internal square drive to DIN 3120 / ISO 1174 with ball reception
- For manual operation

1000V



start from **29,00** EUR

		D1 mm	D2 mm	L mm		Price
117.2353	E10	23	17	55		29,00 €
117.2354	E11	23	20	55		29,00 €
117.2355	E12	23	20	55		29,00 €
117.2356	E14	23	21	55		29,00 €
117.2357	E16	23	24	55		29,00 €
117.2358	E18	23	26	55		29,00 €
117.2359	E20	23	28	55		43,00 €
117.2361	E22	23	29	55		43,00 €
117.2362	E24	23	32	55		43,00 €

117.1151 ... 1159

1/2" BIT SOCKET WITH PROTECTIVE INSULATION FOR HEXAGON SCREWS

- Hexagon socket
- Immersion insulation handle to IEC 60900
- Internal square drive to DIN 3120 / ISO 1174 with ball reception

1000V



start from **50,00** *EUR*

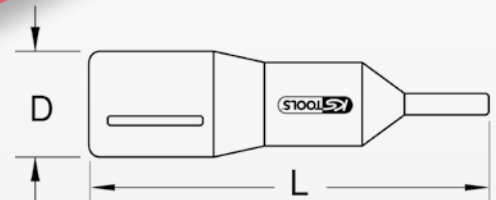

	mm	D mm	L mm		Price
117.1151	4	26	95		50,00 €
117.1152	5	26	95		50,00 €
117.1153	6	26	95		50,00 €
117.1154	8	26	95		50,00 €
117.1155	10	26	95		50,00 €
117.1156	12	26	95		55,50 €
117.1157	14	26	95		55,50 €
117.1158	17	26	95		55,50 €
117.1159	19	26	95		55,50 €

117.1161 ... 1166

1/2" BIT SOCKET WITH PROTECTIVE INSULATION FOR HEXAGON SCREWS, LONG

- Hexagon socket
- Immersion insulation handle to IEC 60900
- Internal square drive to DIN 3120 / ISO 1174 with ball reception

1000V



50,00 *EUR*

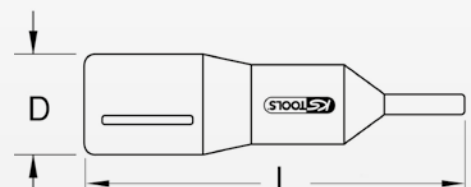

	mm	D mm	L mm		Price
117.1161	4	26	118		50,00 €
117.1162	5	26	118		50,00 €
117.1163	6	26	118		50,00 €
117.1164	8	26	118		50,00 €
117.1165	10	26	118		50,00 €
117.1166	12	26	118		50,00 €

117.1171 ... 1176

1/2" BIT SOCKET WITH PROTECTIVE INSULATION FOR HEXAGON SOCKET SCREWS, EXTRA LONG

- Hexagonal
- Immersion insulation according to IEC 60900
- Internal square drive according to DIN 3120 / ISO 1174 with ball drill groove

1000V

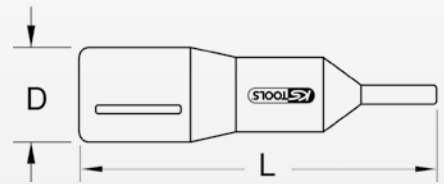

start from **46,00** EUR

	mm	D mm	L mm		Price
117.1171	5	26	156		50,00 €
117.1172	6	26	156		50,00 €
117.1173	5	26	267		46,00 €
117.1174	6	26	267		46,00 €
117.1175	8	26	267		46,00 €
117.1176	10	26	267		46,00 €

117.2434 ... 2443







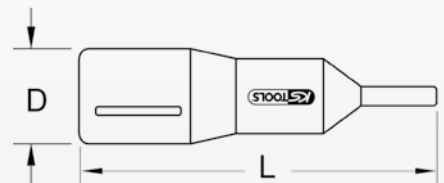



1/2" BIT SOCKET WITH PROTECTIVE INSULATION FOR TORX SCREWS, SHORT

- Torx
- Immersion insulation handle to IEC 60900
- Internal square drive to DIN 3120 / ISO 1174 with ball reception

1000V



43,00 EUR

		D mm	L mm		Preis
117.2434	T20	25	75		43,00 €
117.2435	T25	25	75		43,00 €
117.2436	T27	25	75		43,00 €
117.2437	T30	25	75		43,00 €
117.2438	T40	25	75		43,00 €
117.2439	T45	25	75		43,00 €
117.2441	T50	25	75		43,00 €
117.2442	T55	25	75		43,00 €
117.2443	T60	25	75		43,00 €

117.2444 ... 2453

1/2" BIT SOCKET WITH PROTECTIVE INSULATION FOR TORX SCREWS, LONG

- Torx
- Immersion insulation handle to IEC 60900
- Internal square drive to DIN 3120 / ISO 1174 with ball reception

1000V

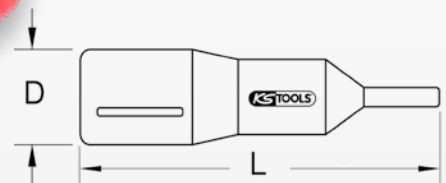

start from **43,00** EUR

		D mm	L mm		Price
117.2444	T20	25	100		43,00 €
117.2445	T25	25	100		43,00 €
117.2446	T27	25	100		43,00 €
117.2447	T30	25	100		43,00 €
117.2448	T40	25	100		43,00 €
117.2449	T45	25	100		46,00 €
117.2451	T50	25	100		46,00 €
117.2452	T55	25	100		46,00 €
117.2453	T60	25	100		46,00 €

117.1285

REDUCING ADAPTER WITH PROTECTIVE INSULATION

- In accordance to DIN 3123 / ISO 3316
- Immersion insulation handle to IEC 60900
- Square drive adaptor to DIN 3120 / ISO 1174 with ball lock
- Matt chrome
- Chrome vanadium

1000V



45,00 EUR



			D mm	L mm	
117.1285	1/2"	3/8"	20	75	

117.1403

1/2" ANGLE SOCKET WRENCH WITH PROTECTIVE INSULATION

- Square drive adaptor to DIN 3120 / 1174 with ball lock
- In accordance to DIN 7436
- Immersion insulation handle to IEC 60900
- With screw adjustment
- Chrome vanadium

1000V



62,50 EUR

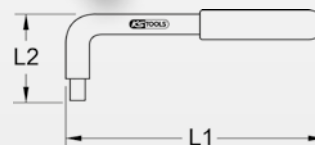

		L1 mm	L2 mm	
117.1403	1/2"	280	70	

117.1671 ... 1696

T-HANDLE ALLEN KEY WITH PROTECTIVE INSULATION

- Hexagon socket
- Immersion insulation handle to IEC 60900
- Extremely versatile

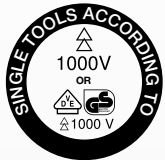

start from **37,50** EUR

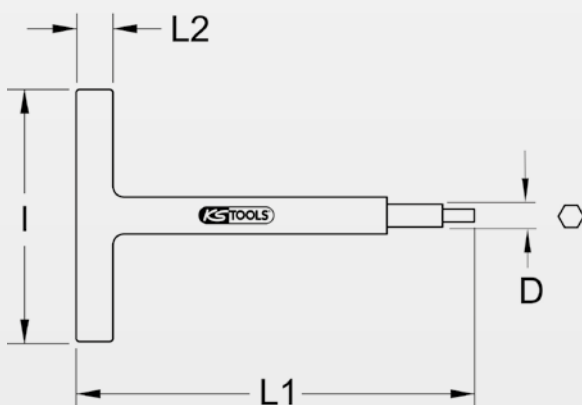

	● mm	l mm	D mm	L1 mm	L2 mm	⚡	Price
117.1671	3	65,0	5,0	120,0	17,5	⚡ 1000V	37,50 €
117.1673	4	65,0	10,0	120,0	19,0	⚡ 1000V	37,50 €
117.1674	4	104,0	15,0	160,0	22,0	⚡ 1000V	44,00 €
117.1675	4	64,0	10,0	200,0	18,0	⚡ 1000V	37,50 €
117.1676	4	94,0	13,0	250,0	19,0	⚡ 1000V	40,00 €
117.1677	5	65,0	11,0	120,0	20,0	⚡ 1000V	37,50 €
117.1678	5	105,0	15,0	160,0	21,0	⚡ 1000V	40,00 €
117.1679	5	65,0	10,0	200,0	18,0	⚡ 1000V	37,50 €
117.1681	5	105,0	15,0	250,0	20,0	⚡ 1000V	37,50 €
117.1682	6	90,0	11,0	120,0	20,0	⚡ 1000V	37,50 €
117.1683	6	105,0	15,0	160,0	21,0	⚡ 1000V	50,00 €
117.1684	6	65,0	11,0	200,0	19,0	⚡ 1000V	43,00 €
117.1742	6	105,0	8,0	250,0	20,0	⚡ 1000V	43,00 €
117.1685	8	105,0	15,0	160,0	21,0	⚡ 1000V	43,00 €
117.1686	8	160,0	13,0	200,0	22,0	⚡ 1000V	43,00 €
117.1687	8	100,0	17,0	250,0	22,0	⚡ 1000V	51,00 €
117.1688	10	160,0	15,0	200,0	20,0	⚡ 1000V	43,00 €
117.1689	10	160,0	15,0	250,0	20,0	⚡ 1000V	43,00 €
117.1691	10	160,0	15,0	300,0	20,0	⚡ 1000V	43,00 €
117.1692	11	160,0	15,0	200,0	20,0	⚡ 1000V	43,00 €
117.1693	12	160,0	16,0	200,0	20,0	⚡ 1000V	43,00 €
117.1694	13	160,0	16,0	200,0	21,0	⚡ 1000V	43,00 €
117.1695	14	160,0	17,0	200,0	21,0	⚡ 1000V	43,00 €
117.1696	17	160,0	20,0	200,0	21,0	⚡ 1000V	43,00 €

117.2412 ... 2421

T-HANDLE TORX L-KEY WITH PROTECTIVE INSULATION

- Torx
- Immersion insulation according to IEC 60900
- solid design



1000V



43,00
EUR

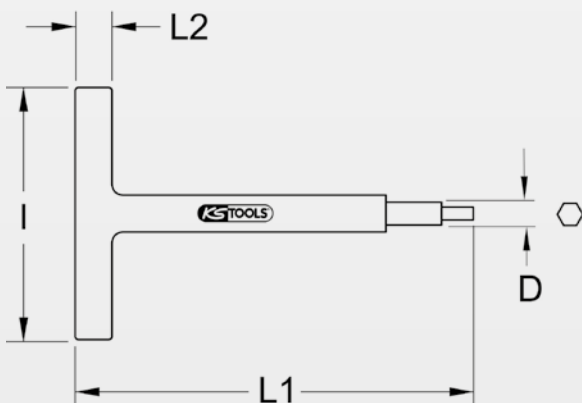

	★	I mm	D mm	L1 mm	L2 mm	⚡	Price
117.2412	T10	63	4	120	13		43,00 €
117.2413	T15	63	4	120	13		43,00 €
117.2414	T20	103	5	120	13		43,00 €
117.2415	T25	103	5	160	15		43,00 €
117.2416	T27	103	6	160	15		43,00 €
117.2417	T30	103	6	160	15		43,00 €
117.2418	T40	103	7	200	15		43,00 €
117.2419	T45	103	7	200	15		43,00 €
117.2421	T50	103	8	200	15		43,00 €

TORQUE WRENCH WITH PROTECTIVE INSULATION

117.3922 ... 1001

FIXED TORQUE WRENCH WITH PROTECTIVE INSULATION

- Immersion insulation according to IEC 60900
- Trigger accuracy: $\pm 4\%$ tolerance of the set scale value and better
- Without scale - with fixed value
- Square drive according to DIN 3120 / ISO 1174 with ball lock
- including calibration declaration of conformity according to DIN EN ISO 6789:2017(E) - traceable to national standards

1000V



start from **425,00** EUR

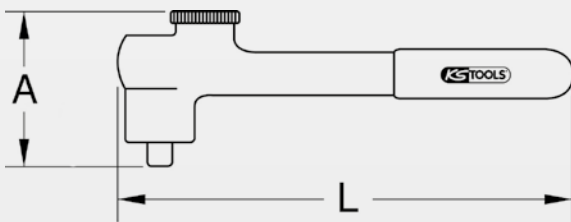

	□	Nm	A mm	L mm	⚡	Price
117.3922	3/8"	5-35	78	210	1000V	425,00 €
117.1001	1/2"	5-35	78	250	1000V	508,50 €

117.1400 ... 1185

MINI TORQUE WRENCH WITH PROTECTIVE INSULATION AND REVERSIBLE RATCHET HEAD

- Immersion insulation according to IEC 60900
- Trigger accuracy: $\pm 4\%$ tolerance of the set scale value and better
- Square drive according to DIN 3120 / ISO 1174 with ball lock
- including calibration declaration of conformity according to DIN EN ISO 6789:2017(E) - traceable to national standards

1000V



start from **623,50** EUR

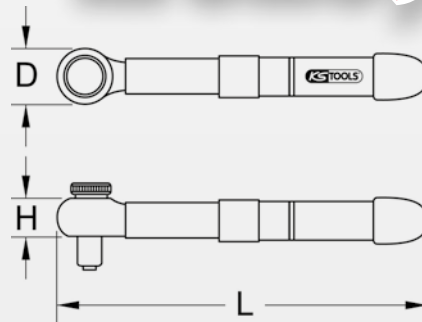

	□	Nm	D mm	H mm	L mm	⚡	Price
117.1400	1/4"	2-10	40	41	200	1000V	704,50 €
117.1402	1/4"	5-25	40	41	200	1000V	704,50 €
117.1184	3/8"	5-25	40	42	200	1000V	623,50 €
117.1185	1/2"	5-25	40	42	200	1000V	779,50 €

117.3805 ... 1303

TORQUE WRENCH WITH PROTECTIVE INSULATION AND REVERSIBLE RATCHET HEAD

- Immersion insulation according to IEC 60900
- Trigger accuracy: $\pm 4\%$ tolerance of the set scale value and better
- Square drive according to DIN 3120 / ISO 1174 with ball lock
- including calibration declaration of conformity according to DIN EN ISO 6789:2017(E) - traceable to national standards

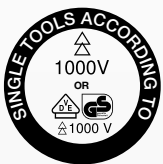

start from **682,00** EUR

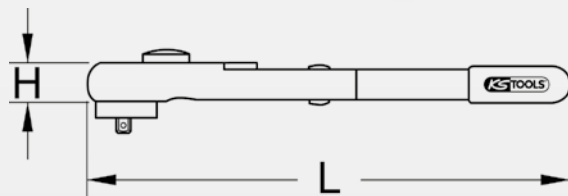

	■	Nm	H mm	L mm	⚡	Price
117.3805	3/8"	5-25	51	280	1000V	682,00 €
117.3810	3/8"	5-50	51	370	1000V	704,50 €
117.1301	1/2"	5-25	61	280	1000V	819,00 €
117.1300	1/2"	5-50	61	370	1000V	788,00 €
117.1302	1/2"	20-100	61	460	1000V	803,50 €
117.1303	1/2"	40-220	61	530	1000V	878,00 €

117.3806 ... 3808

FIXED T-HANDLE TORQUE LIMITER WITH PROTECTIVE INSULATION

- Immersion insulation handle to IEC 60900
- High accuracy
- It is not possible to over tighten the set value
- Without scale - with a fixed adjustable value
- Square drive adaptor to DIN 3120 / ISO 1174 with ball lock



start from **409,50** EUR

	■	Nm	D mm	L1 mm	L2 mm	⚡	Price
117.3806	3/8"	12	36,5	270,0	165,0	1000V	409,50 €
117.3807	3/8"	18	36,5	270,0	165,0	1000V	416,00 €
117.3808	3/8"	25	36,5	270,0	165,0	1000V	434,50 €

117.3802 ... 3804

FIXED TORQUE LIMITER WITH PROTECTIVE INSULATION

- Immersion insulation handle to IEC 60900
- High accuracy
- It is not possible to over tighten the set value
- Without scale - with a fixed adjustable value
- Square drive adaptor to DIN 3120 / ISO 1174 with ball lock

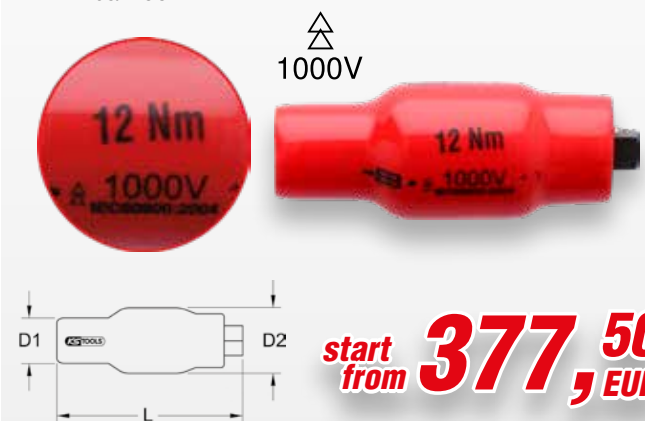

start from **377,50** EUR

	■	■	Nm	D1 mm	D2 mm	L mm	⚡	Price
117.3802	3/8"	3/8"	12	23	27,5	92	1000V	377,50 €
117.3803	3/8"	3/8"	18	23	27,5	92	1000V	371,00 €
117.3804	3/8"	3/8"	25	23	27,5	92	1000V	388,00 €

SCREWDRIVER WITH PROTECTIVE INSULATION

500.6136 ... 6137

PRECISION SCREWDRIVER WITH PROTECTIVE INSULATION FOR PHILLIPS SCREWS PH



- PH
- Insulated to IEC 60900
- Twist end cap
- Color coding



6,00 EUR

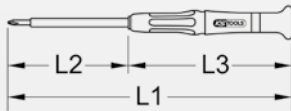

	+	L1 mm	L2 mm	L3 mm	⚡	Price
500.6136	PH 00	132	40	92		6,00 €
500.6137	PH 0	152	60	92		6,00 €

500.6138 ... 6143

PRECISION SCREWDRIVER WITH PROTECTIVE INSULATION FOR SLOTTED SCREWS



- Slotted
- Insulated to IEC 60900
- Twist end cap
- Colour coding



6,00 EUR

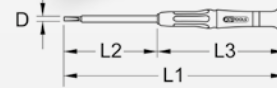

	D mm	L1 mm	L2 mm	L3 mm	⚡	Price
500.6138	1,5	132,0	40,0	92,0		6,00 €
500.6139	1,8	132,0	40,0	92,0		6,00 €
500.6140	2,0	132,0	40,0	92,0		req.
500.6141	2,5	152,0	60,0	92,0		6,00 €
500.6142	3,0	152,0	60,0	92,0		6,00 €
500.6143	3,5	152,0	60,0	92,0		6,00 €

117.0541 ... 0518

VDE SLOTTED SCREWDRIVER

- Slotted
- In accordance to DIN 5264 / DIN ISO 2380
- Insulated to IEC 60900



start from 5,00 EUR

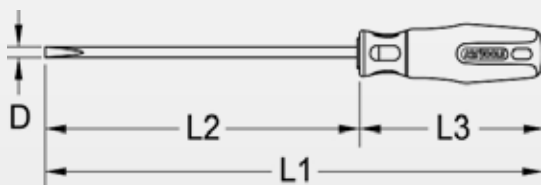

	D mm	L1 mm	L2 mm	L3 mm	⚡	Price
117.0541	2,0	140	60	80		5,00 €
117.0502	2,5	155	75	80		6,00 €
117.0504	3,0	180	100	80		6,00 €
117.0506	3,5	180	100	80		6,00 €
117.0508	4,0	180	100	80		8,00 €
117.0542	4,5	230	125	105		8,00 €
117.0543	4,5	290	175	115		9,00 €
117.0544	4,5	315	200	115		11,50 €
117.0512	5,5	230	125	105		9,00 €
117.0545	5,5	290	175	115		9,00 €
117.0514	6,5	255	150	105		11,00 €
117.0516	8,0	290	175	115		13,00 €
117.0518	10,0	315	200	115		13,00 €

117.0522 ... 1526

VDE PH SCREWDRIVER



- PH
- In accordance to DIN 7438 / DIN ISO 8764
- Insulated to IEC 60900



start from **5,00** EUR

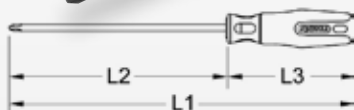

	+	L1 mm	L2 mm	L3 mm	⚡	Price
117.0522	PH 0	140	60	80	⚡ 1000V	5,00 €
117.0524	PH 1	185	80	105	⚡ 1000V	8,00 €
117.1521	PH 1	265	150	115	⚡ 1000V	9,00 €
117.0526	PH 2	205	100	105	⚡ 1000V	9,00 €
117.1523	PH 2	315	200	115	⚡ 1000V	11,00 €
117.0528	PH 3	265	150	115	⚡ 1000V	11,50 €
117.1526	PH 4	315	200	115	⚡ 1000V	12,50 €

117.0532 ... 1535

VDE PZ SCREWDRIVER



- PZ
- In accordance to DIN 7438 / DIN ISO 8764
- Insulated to IEC 60900



start from **5,00** EUR

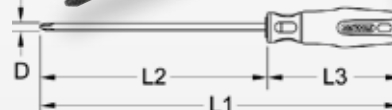

	*	L1 mm	L2 mm	L3 mm	⚡	Price
117.0532	PZ 0	140	60	80	⚡ 1000V	5,00 €
117.0534	PZ 1	185	80	105	⚡ 1000V	8,00 €
117.1533	PZ 1	265	150	115	⚡ 1000V	9,00 €
117.0536	PZ 2	205	100	105	⚡ 1000V	11,00 €
117.1534	PZ 2	315	200	115	⚡ 1000V	11,00 €
117.0538	PZ 3	265	150	115	⚡ 1000V	11,50 €
117.1535	PZ 4	315	200	115	⚡ 1000V	12,50 €

117.1631 ... 1638

HEXAGON SOCKET SCREWDRIVER WITH PROTECTIVE INSULATION



- Hexagon socket
- In accordance to DIN 7439
- Insulated to IEC 60900



start from **13,00** EUR



	mm	L1 mm	L2 mm	L3 mm	⚡	Price
117.1631	1,5	156	75	81	⚡ 1000V	13,00 €
117.1632	2,0	156	75	81	⚡ 1000V	13,00 €
117.1633	2,5	181	100	81	⚡ 1000V	13,00 €
117.1634	3,0	181	100	81	⚡ 1000V	13,00 €
117.1635	4,0	231	125	106	⚡ 1000V	13,00 €
117.1636	5,0	256	150	106	⚡ 1000V	15,00 €
117.1637	6,0	291	175	116	⚡ 1000V	19,00 €
117.1638	8,0	316	200	116	⚡ 1000V	24,00 €

117.0591 ... 0595

SCREWDRIVER FOR SQUARE SOCKET SCREWS



- Interior square screwdriver with protective insulation
- Interior square
- based on DIN 7438 / DIN ISO 8764
- Insulation according to IEC 60900

⚡
1000V



start from **6,00** EUR

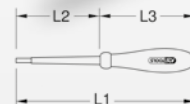

	□	L1 mm	L2 mm	L3 mm	⚡	Price
117.0591	#1	160	80	80	⚡ 1000V	6,00 €
117.0592	#1	255	150	105	⚡ 1000V	11,50 €
117.0593	#2	180	100	80	⚡ 1000V	8,00 €
117.0594	#2	315	200	115	⚡ 1000V	17,00 €
117.0595	#3	265	150	115	⚡ 1000V	11,00 €

117.2235 ... 0558

INSULATED SCREWDRIVER FOR INTERNAL TORX SCREWS

- Torx
- Insulated to IEC 60900

1000V



start from **7,00** EUR

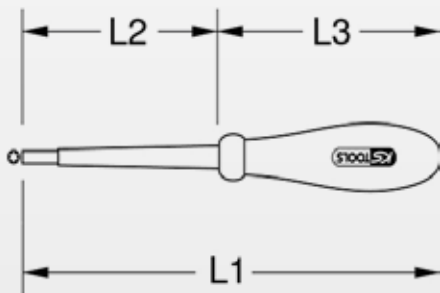

	★	L1 mm	L2 mm	L3 mm	⚡	Price
117.2235	T5	140	60	80	1000V	7,00 €
117.2236	T6	140	60	80	1000V	7,00 €
117.2237	T7	140	60	80	1000V	7,00 €
117.2238	T8	140	60	80	1000V	7,00 €
117.2239	T9	140	60	80	1000V	7,00 €
117.0551	T10	170	80	90	1000V	11,50 €
117.0552	T15	170	80	90	1000V	12,50 €
117.0553	T20	190	100	90	1000V	12,50 €
117.0554	T25	190	100	90	1000V	12,50 €
117.0555	T27	230	125	105	1000V	17,00 €
117.0556	T30	205	115	90	1000V	17,00 €
117.0557	T40	290	175	115	1000V	17,00 €
117.0558	T45	290	175	115	1000V	17,00 €

117.1625

1/4" BIT SCREWDRIVER WITH PROTECTIVE INSULATION AND MAGAZINE

- Insulated to IEC 60900
- For bits to DIN 3126 - C 6,3

1000V



64,50 EUR

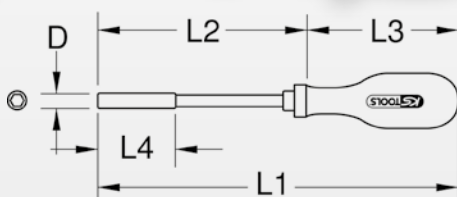

	⬠	D mm	L1 mm	L2 mm	L3 mm	L4 mm	⚡
117.1625	1/4"	12,5	230	120	110	50	1000V



SCREWDRIVER SETS WITH PROTECTIVE INSULATION

500.6165

PRECISION MECHANICS
SCREWDRIVER WITH
PROTECTIVE INSULATION
FOR PHILLIPS SCREWS PH
SET, 7 PCS

- Insulated to IEC 60900
- Twist end cap
- Color coding



47,00
EUR



2 x		+	PH 0 - PH 00
5 x		-	1,5 - 1,8 - 2,0 - 2,5 - 3,0 mm

117.0540

VDE SCREWDRIVER SET,
PH + SLOT, 5 PCS

- In accordance to DIN 5264 / 7437 / 7438 / 8764
- Insulated to IEC 60900



28,00
EUR



1 x		+	PH1
3 x		-	2,5 - 4,0 - 5,5 mm
1 x		-	3,0 mm

117.0550

**VDE SCREWDRIVER SET,
PH + SLOT, 8 PCS**

- In accordance to DIN 5264 / 7437 / 7438 / 8764
- Insulated to IEC 60900



**57,50
EUR**

3 x			PH0 - PH1 - PH2
4 x			2,5 - 4,0 - 5,5 - 6,5 mm
1 x			3,0 mm



117.1160

VDE PLIERS SET, 4 PCS

- Wrap around insulation to IEC 60900

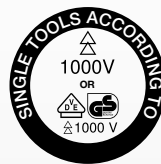

**138,50
EUR**



1 x		200 mm
1 x		160 mm
1 x		180 mm
1 x		160 mm

117.1170

VDE PLIERS AND SCREWDRIVER SET, 5 PCS, VARIATION 1

• Wrap around insulation to IEC 60900

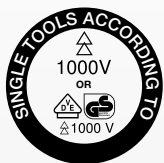

104,00
EUR

1 x		200 mm
1 x		160 mm
2 x		4 - 5,5 mm
1 x		PH2



117.1770

VDE PLIERS AND SCREWDRIVER SET, 5 PCS, VARIATION 2

• Wrap around insulation to IEC 60900

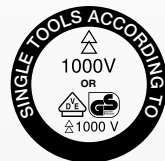

157,00
EUR

1 x		200 mm
1 x		160 mm
2 x		4 - 5,5 mm
1 x		PH2



117.1760

1000V PLIERS SET, 4 PCS, VARIATION 2

- Immersion insulation according to IEC 60900



258,00
EUR

1 x		200 mm
1 x		160 mm
1 x		185 mm
1 x		160 mm



PLIERS WITH PROTECTIVE INSULATION

117.1275 ... 1278

1000 V COMBINATION PLIERS

- In accordance to DIN ISO 5746
- Immersion insulation handle to IEC 60900
- Also suitable for hard wire

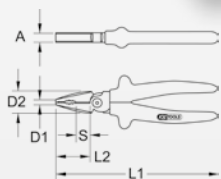

start from **57,50**
EUR

	A mm	D1 mm	D2 mm	L1 mm	L2 mm	S mm	⚡	Price
117.1278	8,5	6,0	25,0	160,0	36,5	13,0	1000V	57,50 €
117.1275	11,0	7,5	28,0	185,0	40,0	16,5	GS 1000V	61,50 €
117.1276	11,5	8,0	28,0	205,0	43,0	18,0	GS 1000V	70,00 €

117.1111 ... 1113

VDE COMBINATION PLIERS

- In accordance to DIN ISO 5746
- Wrap around insulation to IEC 60900
- Suitable for wire

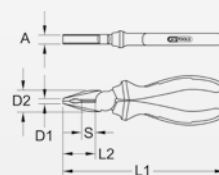

start from **28,00**
EUR

	A mm	D1 mm	D2 mm	L1 mm	L2 mm	S mm	⚡	Price
117.1111	10,0	6,0	24,0	170,0	35,0	2,4	GS 1000V	28,00 €
117.1112	11,0	7,0	27,0	185,0	38,5	2,5	GS 1000V	35,50 €
117.1113	12,0	7,0	30,0	210,0	42,5	3,0	GS 1000V	39,00 €

117.1711 ... 1712

1000 V COMBINATION PLIERS

- In accordance to DIN ISO 5244
- Immersion insulation handle to IEC 60900
- Also suitable for hard wire

1000V

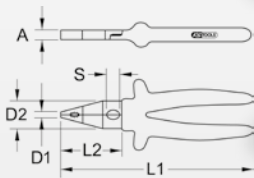

start from **122,00 EUR**

	A mm	D1 mm	D2 mm	L1 mm	L2 mm	S mm	⚡	Price
117.1711	16,0	8,0	30,0	185,0	38,0	16,0		122,00 €
117.1712	16,0	8,5	32,5	205,0	44,0	18,5		133,00 €

117.1114

VDE WIRE STRIPPER, 160 MM

- In accordance to DIN ISO 5232
- Wrap around immersion insulation to IEC 60900
- For wires from 0,8 - 6,0 mm²

1000 V

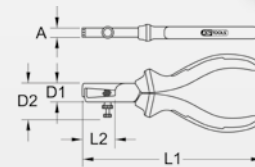

35,50 EUR

	A mm	D1 mm	D2 mm	L1 mm	L2 mm	⚡
117.1114	10,0	17,5	31,5	160,0	36,0	

117.1271

1000 V WIRE STRIPPER, 9,5 MM

- In accordance to DIN ISO 5232
- Wrap around immersion insulation to IEC 60900
- For wires from 0,8 - 6,0 mm²

1000 V

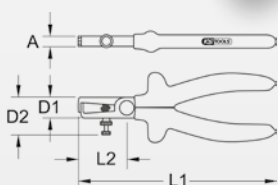

57,50 EUR

	A mm	D1 mm	D2 mm	L1 mm	L2 mm	⚡
117.1271	9,5	18,5	31,5	160	44	

117.1272

1000 V WIRE STRIPPER, 10,5 MM

- Immersion insulation handle to IEC 60900
- Self-adjusting
- With replaceable knives
- For wires from 0,5 - 5,0 mm²
- Cutting holes for the separation of cables and wires

1000V

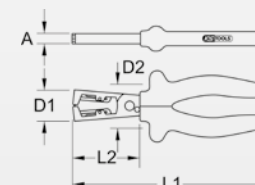

86,50 EUR

	A mm	D1 mm	D2 mm	L1 mm	L2 mm	⚡
117.1272	10,5	28,5	47,5	160,0	20,0	

117.1713



1000 V WIRE STRIPPER, 11 MM

- In accordance to DIN ISO 5232
- Immersion insulation handle to IEC 60900
- For wires from 0,8 - 6,0 mm²

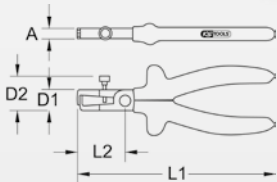
1000V



133,00
EUR

	A mm	D1 mm	D2 mm	L1 mm	L2 mm	
117.1713	11	18,5	20	160	34	

117.1225



1000 V WIRE STRIPPER, 10 MM

- Immersion insulation handle to IEC 60900
- Multifunctional wire strippers
- Self-adjusting
- With replaceable knives
- For wires from 0,5 - 5,0 mm²
- Cutting holes for the separation of cables and wires

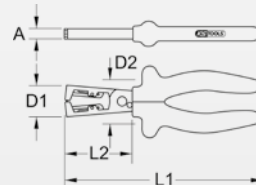
1000V



78,00
EUR

	A mm	D1 mm	D2 mm	L1 mm	L2 mm	
117.1225	10	24	40	185	61	

117.1281



1000 V ELECTRIC SIDE CUTTER, 175 MM

- Immersion insulation handle to IEC 60900
- Wire strippers for wires from 1,5 mm² + 2,5 mm²
- For crimping of insulated cable lugs with Ø 1,5 mm + 2,5 mm

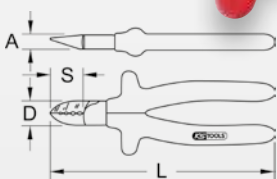
1000V



88,50
EUR

	A mm	D mm	L mm	S mm	
117.1281	10,5	22	175	27	

117.1280



1000 V DRAWING PLIERS, 200 MM

- In accordance to DIN ISO 5745
- Immersion insulation handle to IEC 60900

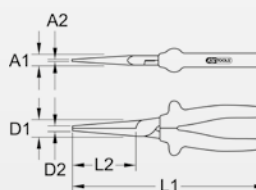
1000V



115,50
EUR

	A1 mm	A2 mm	D1 mm	D2 mm	L1 mm	L2 mm	
117.1280	7,5	6,5	17	4,5	200	65	

117.1714

1000 V DRAWING PLIERS, 200 MM, WITH COATED WORKING HEAD

- In accordance to DIN ISO 5745
- Immersion insulation handle to IEC 60900

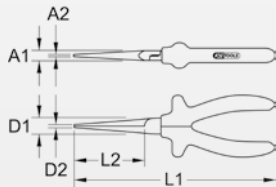

225,50 EUR

	A1 mm	A2 mm	D1 mm	D2 mm	L1 mm	L2 mm	⚡
117.1714	7,5	6,5	19	4,5	200	65	1000V

117.1125

VDE FLAT PLIERS SERRATED, 170 MM

- In accordance to DIN ISO 5745
- Wrap around insulation to IEC 60900

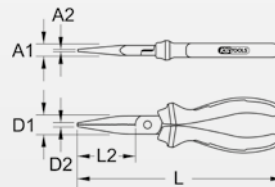

30,00 EUR

	A1 mm	A2 mm	D1 mm	D2 mm	L1 mm	L2 mm	⚡
117.1125	9	3,8	18	3	170	49,5	1000V GS

117.1289

1000 V FLAT PLIERS, 160 MM

- In accordance to DIN ISO 5745
- Immersion insulation handle to IEC 60900

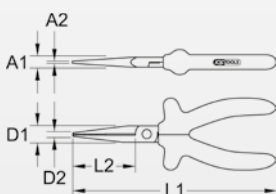

46,00 EUR

	A1 mm	A2 mm	D1 mm	D2 mm	L1 mm	L2 mm	⚡
117.1289	8,5	5,5	15	3,5	160	50	1000V

117.1298

1000 V FLAT PLIERS, 160 MM

- In accordance to DIN ISO 5745
- Immersion insulation handle to IEC 60900

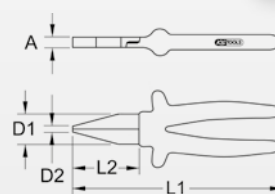

55,50 EUR

	A mm	D1 mm	D2 mm	L1 mm	L2 mm	⚡
117.1298	9	17	4,5	160	34	1000V GS



117.1715
**1000 V FLAT PLIERS, 160 MM,
 WITH COATED WORKING HEAD**

- In accordance to DIN ISO 5745
- Immersion insulation handle to IEC 60900

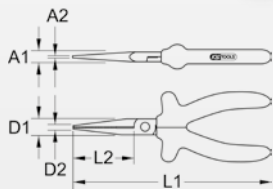
 1000V



115,50
EUR

	A1 mm	A2 mm	D1 mm	D2 mm	L1 mm	L2 mm	
117.1715	11	11	19	5	160	36	



117.1299
**1000 V FLAT PLIERS, LONG,
 160 MM**

- In accordance to DIN ISO 5745
- Immersion insulation handle to IEC 60900

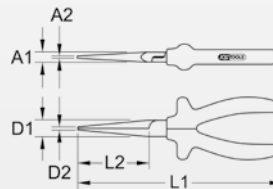
 1000V



55,50
EUR

	A1 mm	A2 mm	D1 mm	D2 mm	L1 mm	L2 mm	
117.1299	7	8,5	16	4	160	51	



117.1716
**1000 V FLAT PLIERS,
 LONG JAW, 160 MM**

- In accordance to DIN ISO 5745
- Immersion insulation handle to IEC 60900

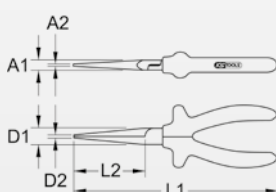
 1000V



115,50
EUR

	A1 mm	A2 mm	D1 mm	D2 mm	L1 mm	L2 mm	
117.1716	13	7,5	18,5	4,5	160	50	



117.1290
**1000 V LONG NOSE PLIERS,
 160 MM**

- In accordance to DIN ISO 5745
- Immersion insulation handle to IEC 60900

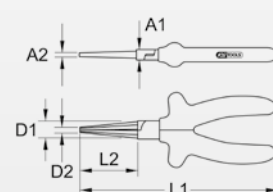
 1000V



61,50
EUR

	A1 mm	A2 mm	D1 mm	D2 mm	L1 mm	L2 mm	
117.1290	9	2,5	14	5,5	160	47,5	

117.1297

1000 V ROUND PLIERS, 160 MM

- In accordance to DIN ISO 5745
- Immersion insulation handle to IEC 60900

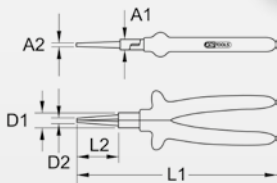

56,50
EUR

	A1 mm	A2 mm	D1 mm	D2 mm	L1 mm	L2 mm	⚡	Price
117.1297	10	3,5	14	6	160	33		

117.1117 ... 1118

VDE LONG NOSE PLIERS, STRAIGHT, 165 MM

- In accordance to DIN ISO 5745
- Wrap around insulation to IEC 60900
- Suitable for medium and hard wire

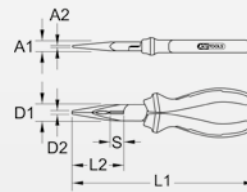

start **32,50**
EUR

	A1 mm	A2 mm	D1 mm	D2 mm	L1 mm	L2 mm	S mm	⚡	Price
117.1117	9	2,9	18	3,2	165	48	2,5		32,50 €
117.1118	11	3,5	22	4,5	215	69	2,5		39,00 €

117.1291 ... 1293

1000 V BENT NOSE PLIER, STRAIGHT, 200 MM

- In accordance to DIN ISO 5745
- Immersion insulation handle to IEC 60900
- For soft and medium wire

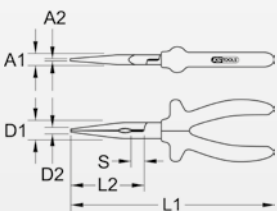
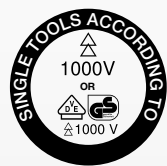

70,00
EUR

	A1 mm	A2 mm	D1 mm	D2 mm	L1 mm	L2 mm	⚡	Price
117.1291	9,5	2,5	16	4	200	74		70,00 €
117.1293	9	2	15,5	3	160	55		70,00 €

117.1717 ... 1718

1000 V LONG NOSE PLIERS, 160 MM

- In accordance to DIN ISO 5745
- Immersion insulation handle to IEC 60900
- For soft and medium wire

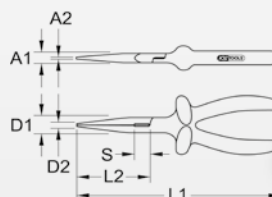

start **133,00**
EUR

	A1 mm	A2 mm	D1 mm	D2 mm	L1 mm	L2 mm	S mm	⚡	Price
117.1717	10	3,5	17,5	4	160	55	10		133,00 €
117.1718	10,5	3,5	18	5	200	74	14		144,50 €

117.1292 ... 1294

1000 V LONG NOSED PLIERS, CURVED

- In accordance to DIN ISO 5745
- Immersion insulation handle to IEC 60900
- For soft and medium wire

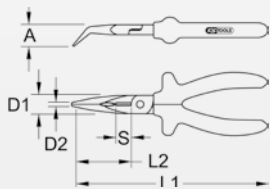
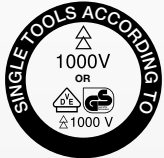

start from **69,00** EUR

	A mm	D1 mm	D2 mm	L1 mm	L2 mm	S mm	⚡	Price
117.1294	9,5	15,5	4	160	51	11	⚡ 1000V	69,00 €
117.1292	9,5	17	4	200	78	14	⚡ 1000V	77,00 €

117.1120 ... 1121

VDE LONG NOSED PLIERS, CURVED

- In accordance to DIN ISO 5745
- Wrap around insulation to IEC 60900
- For soft and medium wire

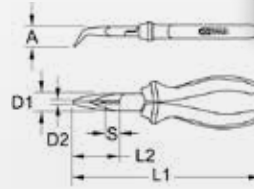

start from **30,00** EUR

	A mm	D1 mm	D2 mm	L1 mm	L2 mm	S mm	⚡	Price
117.1120	9	18	3,2	165	48	2,5	⚡ 1000V	30,00 €
117.1121	11	22	5	205	70	2,5	⚡ 1000V	39,00 €

117.1719

1000 V LONG NOSED PLIERS, CURVED, 200 MM, WITH COATED WORKING HEAD

- In accordance to DIN ISO 5745
- Immersion insulation handle to IEC 60900
- For soft and medium wire

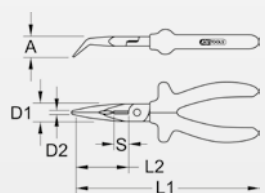

151,00 EUR

	A mm	D1 mm	D2 mm	L1 mm	L2 mm	S mm	⚡
117.1719	12	5	19	200	79	14	⚡ 1000V

117.1268

1000 V LEAD SEALING PLIERS, 160 MM

- Immersion insulation handle to IEC 60900
- Combined with side cutter

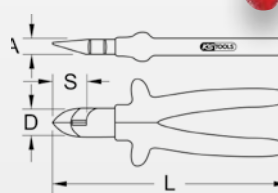

151,00 EUR

	A mm	D mm	L mm	S mm	⚡
117.1268	10	20	160	15	⚡ 1000V

117.1277 ... 1288

1000V DIAGONAL SIDE CUTTER, 160 MM

- In accordance to DIN ISO 5232
- Immersion insulation handle to IEC 60900
- For soft and hard wire

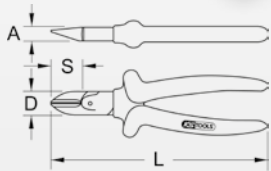

start from **70,00 EUR**

	A mm	D mm	L mm	S mm	⚡	Price
117.1277	11	21,5	160	24		70,00 €
117.1288	11	21,5	180	24		73,00 €

117.1119

VDE DIAGONAL SIDE CUTTER, 160 MM

- In accordance to DIN ISO 5749
- Wrap around insulation to IEC 60900
- For soft and medium wire
- Induction-hardened precision cutting

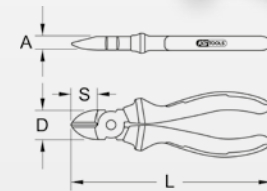

32,50 EUR

	A mm	D mm	L mm	S mm	⚡
117.1119	10	20	160	20	

117.1721 ... 1722

INSULATED FOUR WAY SPANNER, 160 MM

- In accordance to DIN ISO 5232
- Immersion insulation handle to IEC 60900
- For soft and hard wire

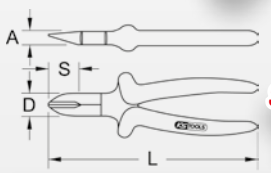

start from **144,50 EUR**

	A mm	D mm	L mm	S mm	⚡	Price
117.1721	26	25,5	160	22		144,50 €
117.1722	27	27	180	25		151,00 €

117.1234

1000 V HIGH LEVERAGE SIDE CUTTER, 200 MM

- In accordance to DIN ISO 5749
- Immersion insulation handle to IEC 60900
- For all types of wire
- 40% power saving

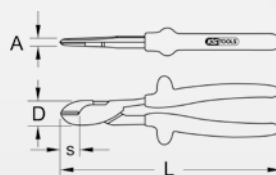

70,00 EUR

	A mm	D mm	L mm	S mm	⚡
117.1234	12	28,5	200	25	

117.1283 ... 1284

1000 V HIGH SIDE CUTTER

- In accordance to DIN ISO 5749
- Immersion insulation handle to IEC 60900
- For all types of wire

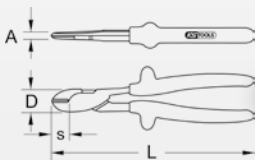
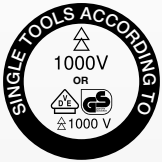

start from 122,00 EUR

	A mm	D mm	L mm	S mm	⚡	Price
117.1283	12,5	29	205	24	1000V	122,00 €
117.1284	13,5	33	260	30	GS 1000V	142,50 €

117.1115 ... 1116

VDE DIAGONAL SIDE CUTTER

- In accordance to DIN ISO 5749
- Wrap around insulation to IEC 60900
- For all types of wire

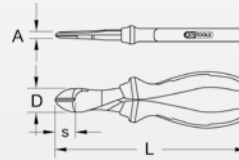

start from 32,50 EUR

	A mm	D mm	L mm	S mm	⚡	Price
117.1115	12	30	190	22,5	GS 1000V	32,50 €
117.1116	12,5	30	205	22,5	GS 1000V	39,00 €

117.1198

1000 V CUTTING PLIERS

- In accordance to DIN ISO 8976
- Wrap around insulation to IEC 60900

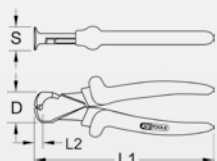

61,50 EUR

	D mm	L mm	L2 mm	S mm	⚡
117.1198	30	160	6,5	23	1000V

117.2000

VDE WATER PUMP PLIERS

- In accordance to DIN ISO 8976
- Wrap around insulation to IEC 60900

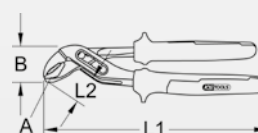

51,00 EUR

	A mm	B mm	L1 mm	L2 mm	⚡
117.2000	33	42	240	32	GS 1000V

117.1207

1000 V WATER PUMP PLIERS

- In accordance to DIN ISO 8976
- Immersion insulation handle to IEC 60900

1000V



115,50
EUR

	A mm	B mm	L1 mm	L2 mm	
117.1207	54	56	260	35	

117.1273 ... 1274

1000 V WATER PUMP PLIERS

- In accordance to DIN ISO 8976
- Immersion insulation handle to IEC 60900

1000V



start from **78,00**
EUR

	A mm	B mm	L1 mm	L2 mm		Price
117.1273	39	35	250	51		78,00 €
117.1274	65	47	300	65		104,00 €

PLIER SETS WITH PROTECTIVE INSULATION

117.1100

VDE PLIERS SET, 4 PCS

- Wrap around insulation to IEC 60900

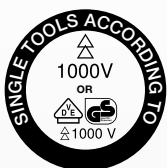

115,50
EUR

1 x	175 mm
1 x	165 mm
1 x	150 mm
1 x	250 mm

117.1700

1000 V PLIERS SET, 4 PCS

- Immersion insulation handle to IEC 60900

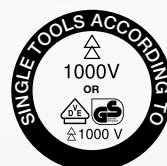

289,00
EUR

1 x	150 mm
1 x	175 mm
1 x	200 mm
1 x	250 mm

117.1110

VDE PLIERS SET, 3 PCS

- Wrap around insulation to IEC 60900

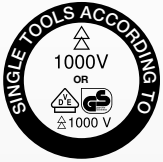

80,50
EUR

1 x		175 mm
1 x		165 mm
1 x		150 mm

117.1710

1000 V PLIERS SET, 3 PCS

- Immersion insulation handle to IEC 60900

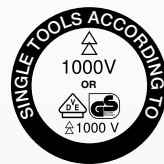

196,50
EUR

1 x		185 mm
1 x		200 mm
1 x		160 mm

CABLE SHEARS WITH PROTECTIVE INSULATION

117.1206

1000 V ELECTRICAL SHEAR, 180 MM

- Immersion insulation handle to IEC 60900
- Only suitable for copper and aluminium wire
- For the cutting of thin wires and sheet metals

1000V

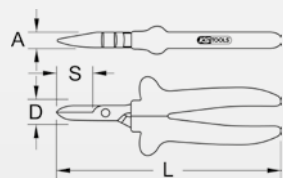

52,00
EUR

	A mm	D mm	L mm	S mm	
117.1206	9	14	180	38	

117.1122 ... 1124

VDE CABLE SHEAR

- Wrap around insulation to IEC 60900
- For lead cable up to max. Ø 50 mm²
- For squeeze free cutting of and on more wiry copper and aluminium cables
- Not suited for steel wire and hard pulled copper cables

1000 V

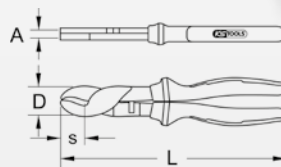

start from **53,00**
EUR

	Ø mm	A mm	D mm	L mm	S mm		Price
117.1122	10,0	10,8	24,5	165,0	15,0		53,00 €
117.1123	12,5	13,0	29,0	215,0	17,5		53,00 €
117.1124	15,0	13,5	45,0	245,0	31,0		75,00 €

117.1269

1000 V CABLE SHEAR, 240 MM

- Immersion insulation handle to IEC 60900
- For and on multi strand copper and aluminium cable
- For lead cable up to max. Ø 50 mm²
- Not suited for steel wire and hard pulled copper cables

1000V

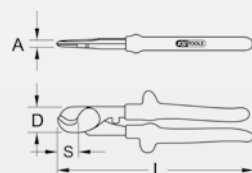

138,50
EUR

	Ø mm	Cutting value mm ²	A mm	D mm	L mm	S mm	
117.1269	15	50	13,5	38	240	25	

117.1107

1000 V SINGLE HANDED CABLE SHEAR

- Immersion insulation handle to IEC 60900
- For and on multi strand copper and aluminium cable
- For lead cable up to max. Ø 50 mm²
- Not suited for steel wire and hard pulled copper cables

1000V

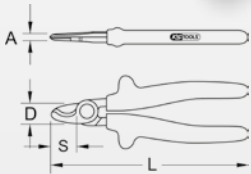

44,00
EUR

	Ø mm	Cutting value mm ²	A mm	D mm	L mm	S mm	⚡	Price
117.1107	15	50	10	23,5	165	24		44,00 €

117.1286

1000 V SINGLE HANDED CABLE SHEAR, 160 MM

- Immersion insulation handle to IEC 60900
- For and on multi strand copper and aluminium cable
- Suitable for wire up to 16 mm²
- Suitable for multi strand wire up to 25 mm²
- Suitable for ultra wire up to 50 mm²
- Not suited for steel wire and hard pulled copper cables

1000V

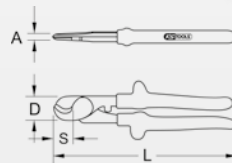

51,00
EUR

	Ø mm	A mm	D mm	L mm	S mm	⚡	Price
117.1286	15	12	25	160	20		

117.1287

1000 V SINGLE HANDED CABLE SHEAR, 165 MM

- Immersion insulation handle to IEC 60900
- For and on multi strand copper and aluminium cable
- Not suited for steel wire and hard pulled copper cables

1000V

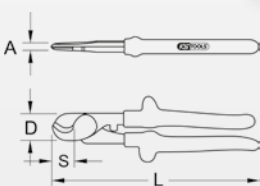

106,00
EUR

	Ø mm	Cutting value mm ²	A mm	D mm	L mm	S mm	⚡	Price
117.1287	17	35	15	27	165	25		

117.1103 ... 1109



1000 V SINGLE HANDED CABLE SHEAR

- Immersion insulation handle to IEC 60900
- For and on multi strand copper and aluminium cable
- Not suited for steel wire and hard pulled copper cables

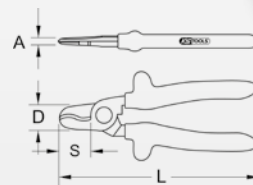
1000V



start from 174,00
EUR

	Ø mm	Cutting value mm ²	A mm	D mm	L mm	S mm	⚡	Price
117.1103	17	35	13	31	165	20,5		174,00 €
117.1109	20	50	18	33,5	210	34		208,00 €

117.1259

1000 V SINGLE HANDED CABLE SHEAR, 215 MM

- Immersion insulation handle to IEC 60900
- For and on multi strand copper and aluminium cable
- Extremely versatile
- Suitable for wire up to 25 mm²
- Suitable for multi-strand wire up to 50 mm²
- Suitable for ultra-wire up to 70 mm²
- Not suited for steel wire and hard pulled copper cables

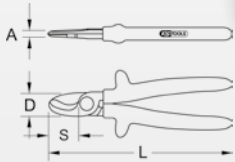

138,50
EUR

	Ø mm	A mm	D mm	L mm	S mm	⚡
117.1259	22	18	31	215	32	

117.1270

1000 V TWO CUT CABLE SHEAR, 200 MM

- Immersion insulation handle to IEC 60900
- For and on multi strand copper and aluminium cable
- Not suited for steel wire and hard pulled copper cables

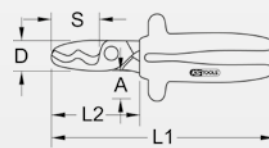

138,50
EUR

	Ø mm	Cutting value mm ²	A mm	D mm	L1 mm	L2 mm	S mm	⚡
117.1270	20	50	13,5	33	200	83	48	

117.1260 ... 1261

CABLE SHEARS WITH PROTECTIVE INSULATION, 600 MM

- Immersion insulation handle to IEC 60900
- For bruise free cutting of copper and aluminium cables
- With interchangeable cutter head
- Not suited for steel wire and hard pulled copper cables

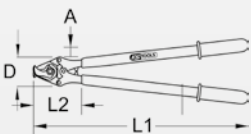

start from 451,00
EUR

	Ø mm	Cutting value mm ²	A mm	D mm	L1 mm	L2 mm	Replacement cutterhead	⚡	Price
117.1260	26	150	16	80	600	80	117.1258		451,00 €
117.1261	33	180	17	86	700	105	117.1263		519,50 €

117.1262

STORAGE BAG FOR CABLE SHEARS WITH PROTECTIVE INSULATION

- From black synthetic leather
- For storage and protection of insulated cable shears



71,00
EUR

	L mm	B mm	
117.1262	650	95 - 190	→ 117.1260 + 117.1261

117.1264

CABLE SHEARS WITH PROTECTIVE INSULATION, 500 MM

- Immersion insulation handle to IEC 60900
- For bruise free cutting of copper and aluminium cables
- Not suited for steel wire and hard pulled copper cables

1000V

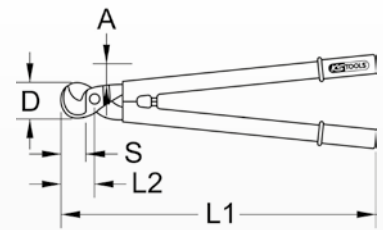

289,00
EUR

	Ø mm	Cutting value mm ²	A mm	D mm	L1 mm	L2 mm	S mm	⚡
117.1264	27	150	15	59	500	58	37	1000V

117.1266

WIRE ROPE CABLE SHEARS WITH PROTECTIVE INSULATION, 600 MM

- Immersion insulation handle to IEC 60900
- Above average cutting edge achieved
- For bruise free cutting for steel and aluminium rope, copper and aluminium cable
- Angular cutting edge tip for cutting single rope cords

1000V

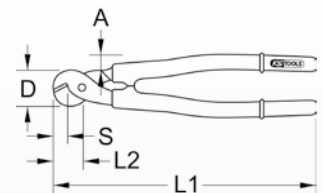

774,50
EUR

	Ø mm	Cutting value mm ²	A mm	D mm	L1 mm	L2 mm	S mm	Replacement cutterhead	⚡
117.1266	20	120	19	90	600	84	17	117.1267	1000V

117.0134

INSULATED CABLE CUTTER

- Immersion insulation according to IEC 60855-1
- Nominal insulation 36 kV
- for crush-free cutting of copper (Ø 14 mm), steel (Ø 7 mm) and aluminium cables (Ø 14 mm)



924,00
EUR

	D mm	L mm	B mm	⚡
117.0134	60	520	130	

117.1304

CABLE KNIFE WITH PROTECTIVE INSULATION, 205 MM

- Insulated to IEC 60900
- With durable, part insulated and straight blade
- Safety handle made out of tough elastic and impact resistant plastic



29,00
EUR

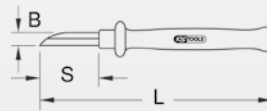

	B mm	S mm	L mm	⚡
117.1304	20,3	53	205	

117.1296

CABLE KNIFE WITH PROTECTIVE INSULATION AND HOOK BLADE, 200 MM

- Insulated to IEC 60900
- With durable blade
- For slitting and stripping cable
- Safety handle made out of tough elastic and impact resistant plastic

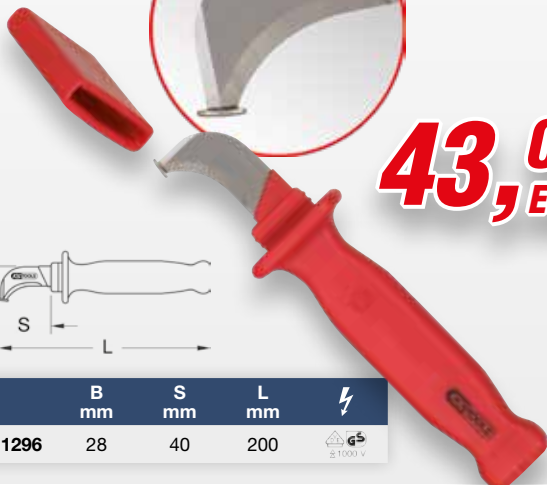

43,00
EUR

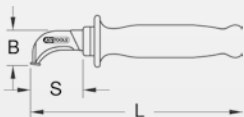

	B mm	S mm	L mm	⚡
117.1296	28	40	200	

117.1390

CABLE KNIFE WITH PROTECTIVE INSULATION, 200 MM

- Insulated to IEC 60900
- With durable, part insulated and straight blade
- Safety handle made out of tough elastic and impact resistant plastic

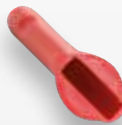

32,50
EUR

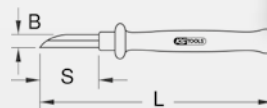

	B mm	S mm	L mm	⚡
117.1390	200	83	48	

117.1391

DISMANTLING KNIFE WITH PROTECTIVE INSULATION, 182 MM

- Insulated to IEC 60900
- With durable and straight blade
- Safety handle made out of tough elastic and impact resistant plastic



24,00
EUR

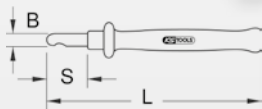

	B mm	S mm	L mm	⚡
117.1391	19	35	182	

117.1305

DISMANTLING KNIFE WITH PROTECTIVE INSULATION, 185 MM

- Insulated to IEC 60900
- With durable and straight blade
- Safety handle made out of tough elastic and impact resistant plastic



23,00
EUR

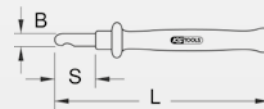

	B mm	S mm	L mm	⚡
117.1305	19	35	185	

117.1392

PAPER SECTION KNIVES WITH PROTECTIVE INSULATION, 205 MM

- Insulated to IEC 60900
- With durable blade
- Safety handle made out of tough elastic and impact resistant plastic



28,00
EUR

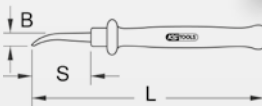

	B mm	S mm	L mm	⚡
117.1392	19	50	205	

117.1331

CABLE KNIFE WITH PROTECTIVE INSULATION AND HOOK BLADE, 200 MM

- Insulated to IEC 60900
- With durable blade
- For slitting and stripping cable
- Safety handle made out of tough elastic and impact resistant plastic



50,00
EUR

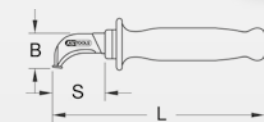

	B mm	S mm	L mm	⚡
117.1331	30	47	200	

117.1393

GUTTA PERCHA KNIFE WITH PROTECTIVE INSULATION, 200 MM

- Insulated to IEC 60900
- With durable blade
- Safety handle made out of tough elastic and impact resistant plastic



28,00 EUR

	B mm	S mm	L mm	⚡
117.1393	12	50	200	

117.1320

PAPER SECTION KNIVES WITH PROTECTIVE INSULATION, 210 MM

- Insulated to IEC 60900
- With durable blade
- Suitable for sector cable
- Safety handle made out of tough elastic and impact resistant plastic

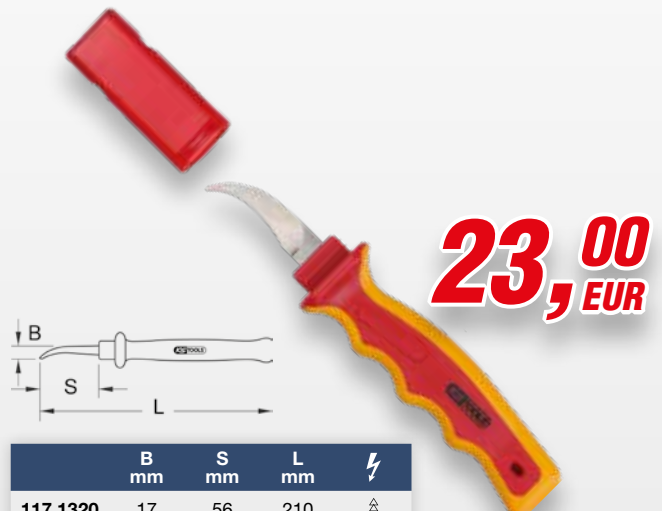

23,00 EUR

	B mm	S mm	L mm	⚡
117.1320	17	56	210	

117.1394

SETTLING KNIFE WITH PROTECTIVE INSULATION, 165 MM

- Insulated to IEC 60900
- With durable blade
- Safety handle made out of tough elastic and impact resistant plastic

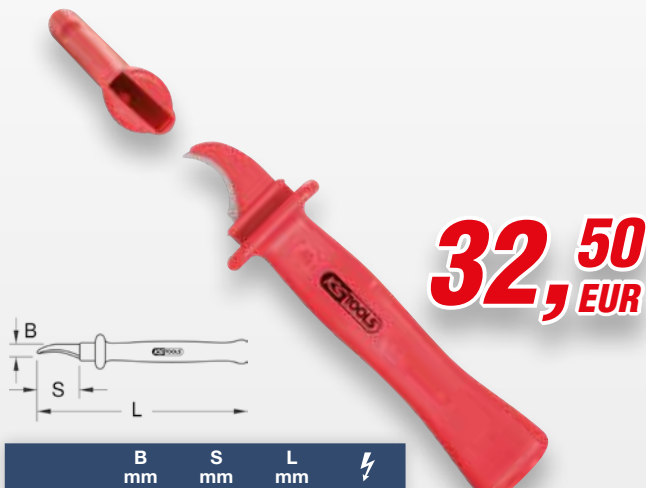

32,50 EUR

	B mm	S mm	L mm	⚡
117.1394	21	35	165	

117.1328

SETTLING KNIFE WITH PROTECTIVE INSULATION, 180 MM

- Insulated to IEC 60900
- With durable blade
- Safety handle made out of tough elastic and impact resistant plastic

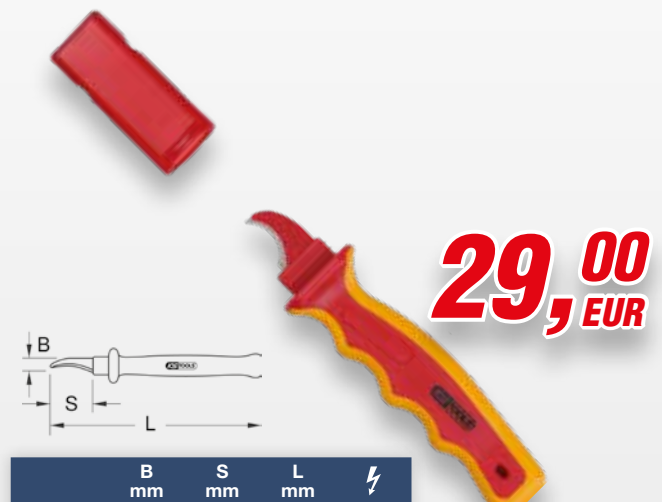

29,00 EUR

	B mm	S mm	L mm	⚡
117.1328	21,2	30	180	

117.1395

CABLE STRIPPING BLADES WITH PROTECTIVE INSULATION, 195 MM

- Insulated to IEC 60900
- With durable blade
- Safety handle made out of tough elastic and impact resistant plastic



	B mm	S mm	L mm	⚡
117.1395	13	45	195	

117.1326

GUTTA PERCHA KNIFE WITH PROTECTIVE INSULATION, 250 MM

- Insulated to IEC 60900
- With durable blade
- Safety handle made out of tough elastic and impact resistant plastic

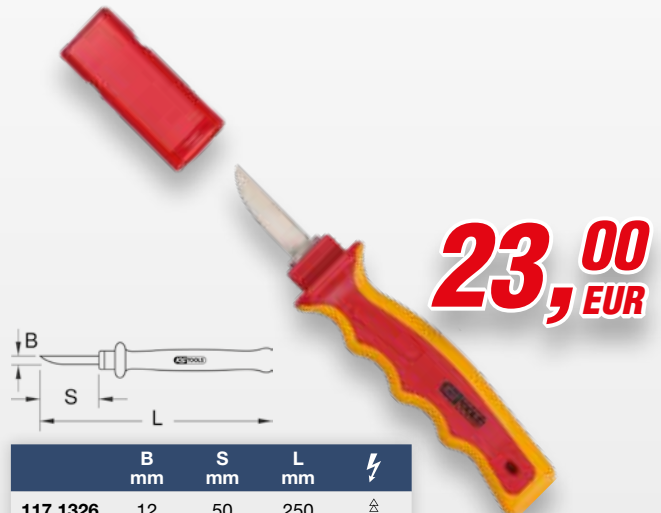

	B mm	S mm	L mm	⚡
117.1326	12	50	250	

117.1396

CABLE STRIPPING BLADES WITH PROTECTIVE INSULATION, 200 MM

- Insulated to IEC 60900
- With durable blade
- Safety handle made out of tough elastic and impact resistant plastic



	B mm	S mm	L mm	⚡
117.1396	11	50	200	

117.1360

CABLE STRIPPING BLADES WITH PROTECTIVE INSULATION, 200 MM

- Insulated to IEC 60900
- With durable blade
- Safety handle made out of tough elastic and impact resistant plastic

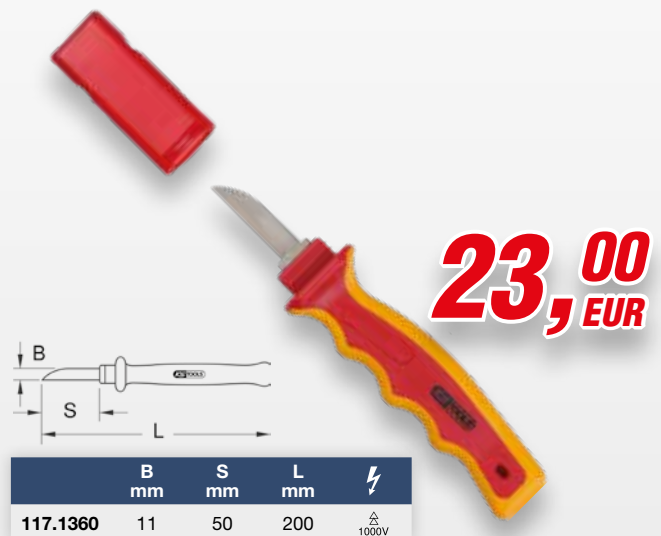

	B mm	S mm	L mm	⚡
117.1360	11	50	200	

117.3901

CABLE SHEATH CUTTER WITH PROTECTIVE INSULATION, 240 MM

- Insulated to IEC 60900
- With durable and straight blade
- For stripping all insulation layers from cables
- Replaceable double knife
- Cutting depth adjustable
- Suitable for longitudinal and round cutting



1000V



354,50 EUR

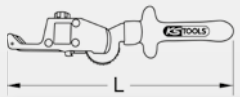

	L mm	Ø Wire mm	Replacement blades	⚡
117.3901	240	> 25	117.3902	1000V

117.1329

CABLE STRIPPING BLADES WITH PROTECTIVE INSULATION, 200 MM

- Insulated to IEC 60900
- With durable blade
- Safety handle made out of tough elastic and impact resistant plastic

1000V



29,00 EUR

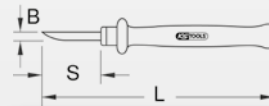

	B mm	S mm	L mm	⚡
117.1329	13	45	200	1000V

117.1148

CABLE KNIFE WITH PROTECTIVE INSULATION AND REPLACEABLE BLADE, 200 MM

- Insulated to IEC 60900
- With durable, partially insulated and replaceable blade
- Safety handle made out of tough elastic and impact resistant plastic

1000V



32,50 EUR

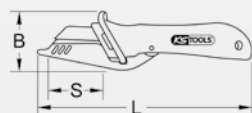

	B mm	S mm	L mm	⚡	Replacement blades
117.1148	21,5	45	189	1000V	117.1149

117.4273

CABLE SHEATH SAW WITH PROTECTIVE INSULATION, 330 MM

- Insulated handle to IEC 60900
- Adjustable and replaceable saw blade

1000V



122,00 EUR

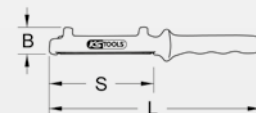

	B mm	S mm	L mm	⚡	Replacement blades
117.4273	40	330	175	1000V	117.4274

117.1370 ... 1366

INSULATION STRIPPING PLIERS

- For cutting and stripping the cable sheath
- Limited cutting depth
- No damage to internal conductor



start from **1.723,00** EUR

	Ø mm	D mm	L mm	Price
117.1370	25-52	140	300	1.723,00 €
117.1366	45-75	150	300	1.801,00 €

117.1365

DISMANTLING PLIERS WITH PROTECTIVE INSULATION, 25-52 MM

- Insulated to IEC 60900
- For cutting and stripping the cable sheath
- Limited cutting depth
- No damage to internal conductor



1000V start from **2.334,00** EUR

	Ø mm	D mm	L mm	⚡
117.1365	25-52	140	300	1000V

ELECTRICAL INSULATING TAPE

141.6010

PVC INSULATION TAPE SET, 8 PCS

- Good resistance to abrasion and corrosion and/or moisture
- High di-electric strength and good mechanical protection
- Conforms to BS3924
- Temperature resistance of 0°C to +90°



req.

	B mm	L m
141.6010	19	10

141.6000 ... 6001

SELF WELDING REPAIR TAPE, 18 MM

- Excellent weather resistance
- Temperature resistance of -40°C to +90°C
- With a tape thickness of 0,5 mm
- Made from Polyisobutylene tape



start from **14,00** EUR

	Colorcode	B mm	L m	Price
141.6000	●	18	10	14,00 €
141.6001	●	38	10	39,00 €

117.4231 ... 4233

ADHESIVE TAPE WITH PROTECTIVE INSULATION

- For working environment of voltages AC 1000 V and DC 1500 V
- On a roll

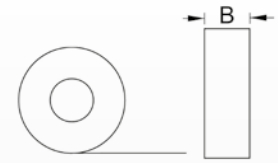

start from **26,00** EUR

	Colorcode	B mm	L m	⚡	Price
117.4231	●	52	10		26,00 €
117.4232	●	102	10		39,00 €
117.4233	●	102	10		39,00 €

STRIPPING PLIERS

115.1028 ... 1029

AUTOMATIC WIRE STRIPPER

- Automatically adjusts to the respective diameters
- For copper and aluminium wires
- Durable clamping jaw for the adherence of the wire

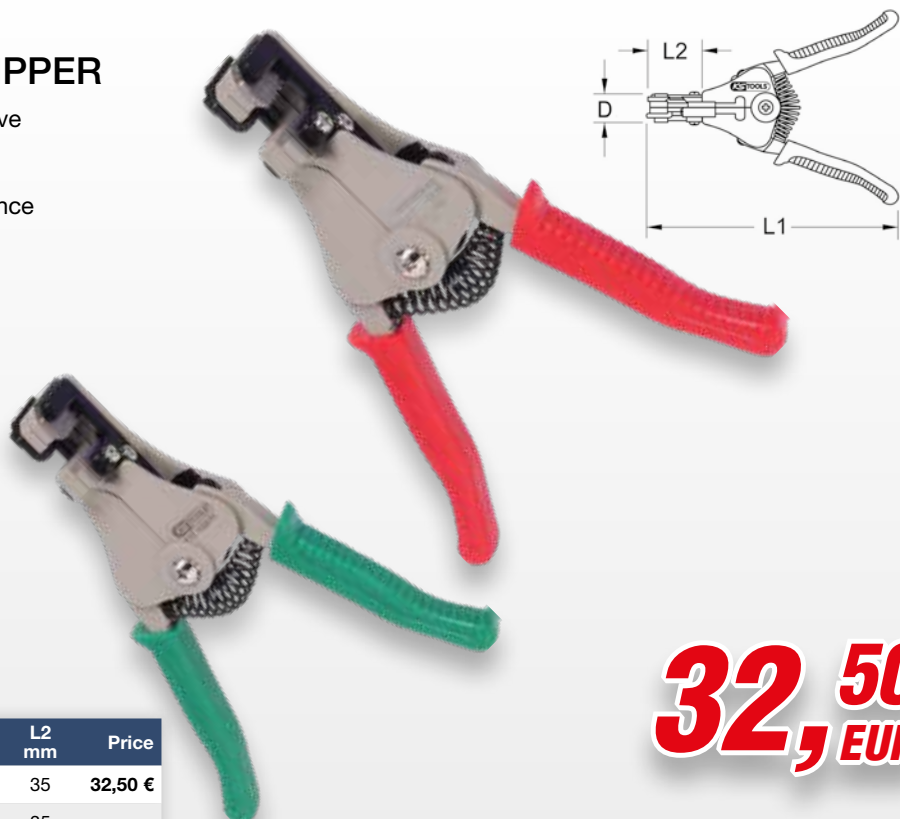

32,50 EUR

	Ø mm	AWG	D mm	L1 mm	L2 mm	Price
115.1028	0,5 - 2	20 - 14	20	170	35	32,50 €
115.1029	1 - 3,2	18 - 8	20	170	35	req.

CRIMP TOOLS

115.1425

CRIMPING PLIERS FOR NON INSULATED TERMINALS, 220 MM

- Safety lock
- Inserts lock and to they click to prevent possible misuse
- Ratchet function
- Adjustment of the crimping pressure
- Easy to change the crimp heads through quick locking device



63,50
EUR

	● mm ²	AWG	L1 mm	L2 mm	L3 mm	
115.1425	0,5 - 1 / 1,5 - 2,5 / 4 - 6	22 - 18 / 16 - 14 / 12 - 10	220	50	34	115.1415

115.1430

CRIMPING PLIERS FOR NON INSULATED TERMINALS, 220MM

- Safety lock
- Inserts lock and to they click to prevent possible misuse
- Ratchet function
- Adjustment of the crimping pressure
- Easy to change the crimp heads through quick locking device



84,50
EUR

	● mm ²	AWG	L1 mm	L2 mm	L3 mm	
115.1430	1,5 / 2,5 / 6 / 10	20 - 18 / 16 - 14 / 12 - 10 / 8	220	50	34	115.1416

115.1440 ... 1450

CRIMPING PLIERS FOR NON INSULATED TERMINALS, 220 MM

- Safety lock
- Inserts lock and to they click to prevent possible misuse
- Ratchet function
- Adjustment of the crimping pressure
- Easy to change the crimp heads through quick locking device

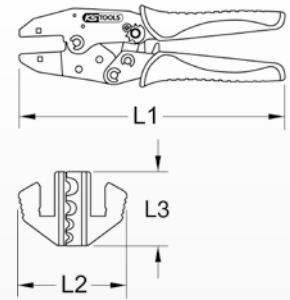

start from **83,50** EUR

	● mm ²	AWG	L1 mm	L2 mm	L3 mm	☞	Price
115.1440	0,5 / 0,75 / 1 / 1,5 / 2,5 / 4	22 / 20 / 18 / 16 - 14 / 12 - 10	220	50	34	115.1418	84,50 €
115.1450	6 / 10 / 16	10 / 8 / 6	220	50	34	115.1420	83,50 €

115.1435 ... 115.1455

CRIMPING PLIERS FOR SPADE TERMINALS

- Safety lock
- Inserts lock and to they click to prevent possible misuse
- Ratchet function
- Adjustment of the crimping pressure
- Easy to change the crimp heads through quick locking device

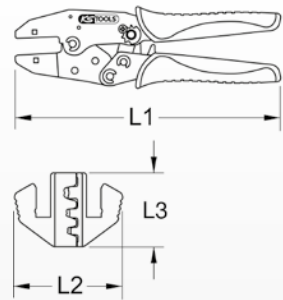

start from **83,50** EUR

	● mm ²	AWG	L1 mm	L2 mm	L3 mm	☞	Price
115.1435	0,5 - 1,0 / 1,5 - 2,5 / 4,0 - 6,0	20 - 18 / 16 - 14 / 12 - 10	220	50	34	115.1417	85,50 €
115.1455	2,5 / 0,5 / 8 / 10	14 - 22 / 8 - 6	220	50	34	115.1421	83,50 €

115.1445

CRIMPING PLIERS FOR COAXIAL TERMINALS

- Safety lock
- Inserts lock and to they click to prevent possible misuse
- Ratchet function
- Adjustment of the crimping pressure
- Easy to change the crimp heads through quick locking device



83,500
EUR

● mm ²	AWG	L1 mm	L2 mm	L3 mm	👉
1,72 / 2,50 / 5,40 / 6,48 / 8,23	RG58 / RG59 / RG62	220	50	34	115.1419

115.1460 ... 115.1470

CRIMPING PLIERS FOR WESTERN TERMINALS, RJ22

- Safety lock
- Inserts lock and to they click to prevent possible misuse
- Ratchet function
- Adjustment of the crimping pressure
- Easy to change the crimp heads through quick locking device



87,50
EUR



● mm ²	AWG	L1 mm	L2 mm	L3 mm	👉	Price
115.1460	RJ22	22-24	220	50	34	115.1422 87,50 €
115.1465	RJ11 / RJ12	22-24	220	50	34	115.1423 87,50 €
115.1470	RJ45	22-24	220	50	34	115.1424 req.

115.1480

ELECTRICIANS CRIMPING PLIERS SET, 3 PCS

- Safety lock
- Inserts lock and to they click to prevent possible misuse
- Ratchet function
- Adjustment of the crimping pressure
- Easy to change the crimp heads through quick locking device

**req.**

1 x		220 mm
1 x		Ø 0,5 - 6,0 mm
1 x		Ø 0,5 - 10,0 mm

115.1490

NET WORKING CRIMPING PLIERS SET, 5 PCS

- Safety lock
- Inserts lock and to they click to prevent possible misuse
- Ratchet function
- Adjustment of the crimping pressure
- Easy to change the crimp heads through quick locking device

**req.**

1 x		220 mm
1 x		AWG : 22 - 14 - 6 - 8
1 x		AWG : 22 - 24
1 x		AWG : 22 - 24
1 x		AWG : 22 - 24

115.1520

CRIMPING PLIERS FOR SOLARLOK

- Safety lock
- Inserts lock and to they click to prevent possible misuse
- Ratchet function
- Adjustment of the crimping pressure
- Easy to change the crimp heads through quick locking device



151,00
EUR

	● mm ²	AWG	L1 mm	L2 mm	L3 mm	
115.1520	6 / 4 / 2,5 / 1,5	10 - 15	220	50	34	115.1412

115.1521

CRIMPING PLIERS FOR SOLAR COUPLER MC 3

- Safety lock
- Inserts lock and to they click to prevent possible misuse
- Ratchet function
- Adjustment of the crimping pressure
- Easy to change the crimp heads through quick locking device



156,00
EUR

	● mm ²	AWG	L1 mm	L2 mm	L3 mm	
115.1521	4 / 6 / 2,5	12 / 10 / 14	220	50	34	115.1413

115.1522

CRIMPING PLIERS FOR SOLAR COUPLER MC 4

- Safety lock
- Inserts lock and to they click to prevent possible misuse
- Ratchet function
- Adjustment of the crimping pressure
- Easy to change the crimp heads through quick locking device



156,00

EUR

	● mm ²	AWG	L1 mm	L2 mm	L3 mm	👤
115.1522	2,5 / 4 / 6	14 / 12 / 10	220	50	34	115.1414

115.1400

CRIMPING TOOL SET, 283 PCS

- Safety lock
- Inserts lock and to they click to prevent possible misuse
- Ratchet function
- Adjustment of the crimping pressure



1 x		220 mm
1 x		Ø 0,5 - 4,0 mm
1 x		Ø 1,5 - 10,0 mm
1 x		Ø 0,5 - 6,0 mm
1 x		Ø 0,5 - 4,0 mm
1 x		RG 58 - RG 71
1 x		1,0 - 3,2 mm
1 x		

183,00

EUR

150.1025

CABLE ROUTING AID SET, 5 PCS

- prevents damage to cable insulation
- helps the user to thread or pull out cables or probes if there are obstacles or components with sharp edges
- different diameters and lengths provide various options for adaptation
- rounded opening at the handle end allows cables or probes to be handled easily without causing damage
- with 4 different attachments



1 x		115 mm
2 x		Länge 127mm: Ø 11,0 / 13,0 mm Länge 127 mm: Ø 6,0 / 8,0 mm
2 x		Länge 227 mm: Ø 6,0 / 8,0 mm Länge 227 mm: Ø 11,0 / 13,0 mm

80,50 EUR

LED LAMPS WITH PROTECTIVE INSULATION

117.1650

LED LAMP WITH PROTECTIVE INSULATION, 90 MM

- Insulated handle to IEC 60900
- Includes AA-Lithium batteries



	D mm	L mm	Replacement battery	
117.1650	28	90	AA-Lithium	

1000V

121,00 EUR

TWEEZERS AND MIRRORS WITH PROTECTIVE INSULATION

117.1623 ... 1624

TWEEZERS WITH PROTECTIVE INSULATION, CURVED

- Insulated handle to IEC 60900
- Wrap insulation



	B mm	L mm		Price
117.1623	11,5	145		45,00 €
117.1624	15,5	200		56,50 €



start from 45,00 EUR

117.1626 ... 1629

TWEEZERS WITH PROTECTIVE INSULATION

- Ideal for removing cladding parts or covers

	B mm	L mm	⚡	Price
117.1626	11	130	1000V	37,50 €
117.1627	13,5	130	1000V	37,50 €
117.1628	15	145	1000V	37,50 €
117.1629	15,5	200	1000V	56,50 €

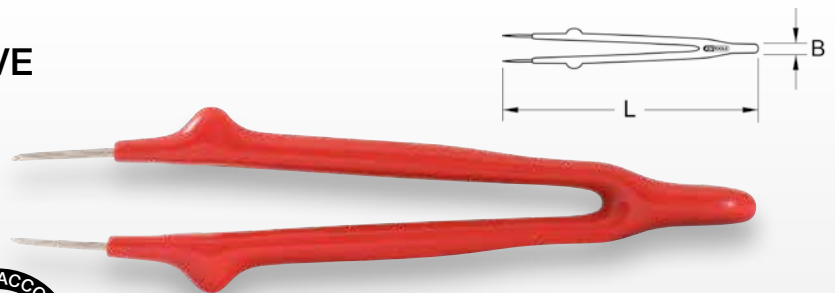

start from **37,50** EUR

117.1630

SEARCH MIRROR WITH PROTECTIVE INSULATION, 21 MM, 175 MM

- Insulated handle to IEC 60900

1000V

	D mm	L mm	⚡
117.1630	21	175	1000V



56,50 EUR

117.2408 ... 2411

SEARCH MIRROR WITH PROTECTIVE INSULATION

- Insulated handle to IEC 60900
- Flexible
- Insulated

	Magnification	Ø mm	L mm	⚡	Price
117.2408	0 x	40	590	1000V	196,50 €
117.2409	0 x	58	590	1000V	209,00 €
117.2411	4 x	54	590	1000V	216,50 €

1000V

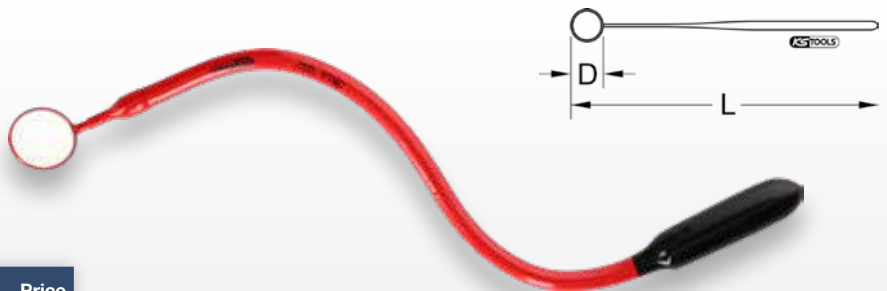

start from **196,50** EUR

117.2322 ... 2324

FLEXIBLE MAGNETIC JACK WITH PROTECTIVE INSULATION

- Insulated handle to IEC 60900
- Flexible shaft
- Special tool steel

	Load capacity kg	Ø mm	L mm	⚡	Price
117.2322	0,25	14	420	1000V	43,00 €
117.2323	1	15	470	1000V	144,50 €
117.2324	1,8	16,5	520	1000V	144,50 €

1000V



start from **43,00** EUR

TOOL RANGES WITH PROTECTIVE INSULATED TOOLS

Especially with special tools for e-mobility professional competence is crucial. We come from practice and work for the practice. Know with this know-how the wishes of our customers to suitable tools also as assortments offer.

With the workshop trolley E10 from our high-quality Performance Plus line, we even offer a complete electric/hybridworkplace. With the right tools, additionally equipped with the decisive equipment for surface and personal protective equipment.

PRACTICE-ORIENTED

CLEVERLY PUT TOGETHER

MANY SMART COMBINATIONS



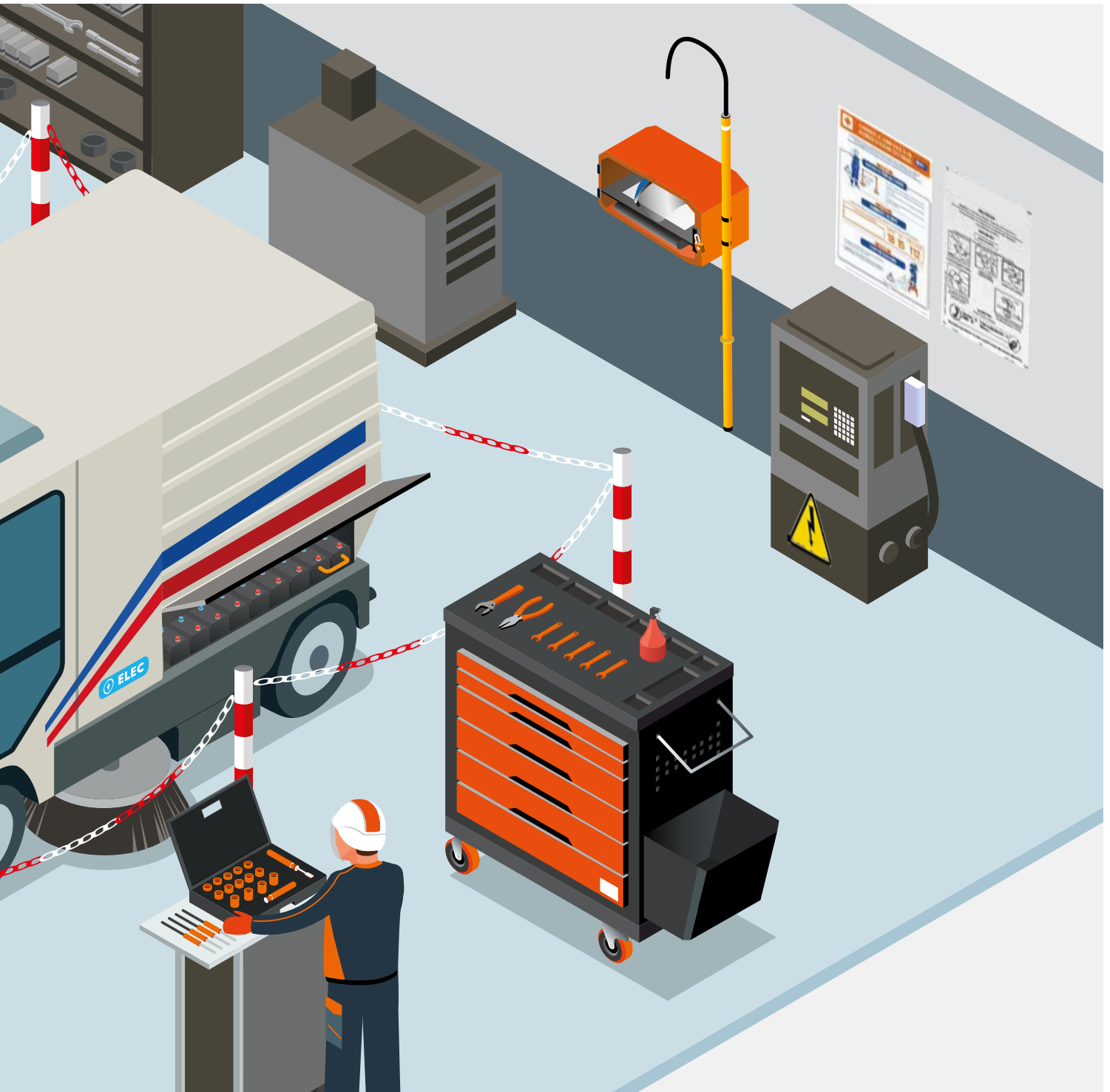

TOOL CASE WITH PROTECTIVE INSULATED TOOLS

117.1877

1/4" INSULATED SOCKET WRENCH SET, 22 PCS

- Insulated handle to IEC 60900

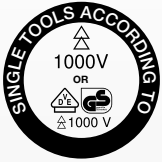

621,50
EUR



1 x		1/4"
4 x		1/4": 50 - 75 - 100 - 150 mm
1 x		1/4"
1 x		1/4"
10 x		1/4": 5 - 6 - 7 - 8 - 9 - 10 - 11 - 12 - 13 - 14 mm
5 x		1/4": 3 - 4 - 5 - 6 - 8 mm

117.1876

1/4" INSULATED SOCKET WRENCH SET, 21 PCS

- Insulated handle to IEC 60900

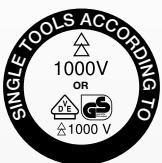

1 x		1/4": 5 - 25 Nm
3 x		1/4": 75 - 100 - 150 mm
2 x		1/4"
5 x		1/4": 6 - 8 - 10 - 13 - 14 mm
3 x		1/4": 5 - 6 - 8 mm
3 x		1/4": 4 - 5,5 - 6,5 mm
2 x		1/4": PH1 - PH2
2 x		1/4": PZ1 - PZ2

808,50
EUR



117.1878

1/4" INSULATED SOCKET WRENCH SET, 21 PCS

- Insulated handle to IEC 60900

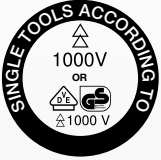

993,50 EUR

1 x		1/4": 5 - 25 Nm
4 x		1/4": 50 - 75 - 100 - 150 mm
1 x		1/4"
10 x		1/4": 5 - 6 - 7 - 8 - 9 - 10 - 11 - 12 - 13 - 14 mm
5 x		1/4": 3 - 4 - 5 - 6 - 8 mm

117.1877

1/4" INSULATED SOCKET WRENCH SET, 22 PCS

- Insulated handle to IEC 60900

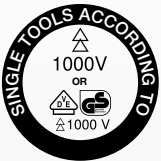

621,50 EUR



1 x		1/4"
4 x		1/4": 50 - 75 - 100 - 150 mm
1 x		1/4"
1 x		1/4"
10 x		1/4": 5 - 6 - 7 - 8 - 9 - 10 - 11 - 12 - 13 - 14 mm
5 x		1/4": 3 - 4 - 5 - 6 - 8 mm

117.1882

3/8" INSULATED SOCKET WRENCH SET, 16 PCS

- Insulated handle to IEC 60900



909,50
EUR

1 x		3/8"
2 x		3/8": 125 - 250 mm
1 x		3/8"
8 x		3/8": 10 - 11 - 12 - 13 - 14 - 17 - 19 - 22 mm
3 x		3/8": 5 - 6 - 8 mm
1 x		25 Nm



117.1883

1/2" INSULATED SOCKET WRENCH SET, 15 PCS

- Insulated handle to IEC 60900

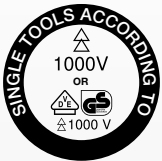

582,00
EUR

1 x		1/2"
2 x		1/2": 125 - 250 mm
1 x		1/2"
8 x		1/2": 10 - 12 - 13 - 14 - 17 - 19 - 22 - 24 mm
3 x		1/2": 5 - 6 - 8 mm



117.1850

INSULATED SOCKET WRENCH SET, 16 PCS, 3/8"

- Insulated handle to IEC 60900

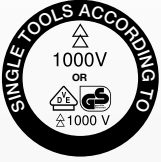

821,00
EUR

1 x		3/8"
2 x		3/8": 125 - 250 mm
1 x		3/8"
8 x		3/8": 10 - 11 - 12 - 13 - 14 - 17 - 19 - 22 mm
3 x		3/8": 5 - 6 - 8 mm
1 x		3,5 mm



117.1885

3/8" INSULATED SOCKET WRENCH SET, 16 PCS

- Insulated handle to IEC 60900

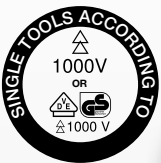

977,00
EUR

1 x		3/8"
2 x		3/8": 125 - 250 mm
3 x		3/8": 13 - 17 - 19 mm
4 x		3/8": 5 - 6 - 8 - 10 mm
1 x		3/8": 5 mm
1 x		2,5 mm
2 x		5 - 6 mm
1 x		Ø 25mm
1 x		160 mm



117.1881

3/8" INSULATED SOCKET WRENCH SET, 14 PCS

- Insulated handle to IEC 60900

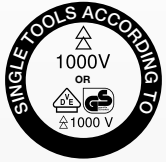

1.571,00 EUR

1 x		3/8": 5 - 50 Nm
2 x		3/8": 125 - 250 mm
5 x		3/8": 10 - 13 - 14 - 17 - 19 mm
5 x		3/8": 4 - 5 - 6 - 8 - 10 mm
1 x		3/8": 95 - 150 mm

117.1888

3/8" INSULATED SOCKET WRENCH SET, 13 PCS

- Insulated handle to IEC 60900



556,00 EUR



1 x		3/8"
2 x		3/8": 125 - 250 mm
1 x		3/8"
5 x		3/8": 8 - 10 - 13 - 17 - 19 mm
4 x		3/8": 4 - 5 - 6 - 8 mm

117.1886

3/8" INSULATED SOCKET WRENCH SET, 13 PCS

- Insulated handle to IEC 60900

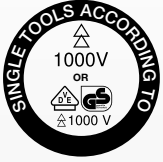

793,00
EUR

1 x		3/8"
2 x		3/8": 125 - 250 mm
1 x		3/8"
5 x		3/8": 8 - 10 - 13 - 17 - 19 mm
4 x		3/8": 4 - 5 - 6 - 8 mm



117.1887

3/8" INSULATED SOCKET WRENCH SET, 11 PCS

- Insulated handle to IEC 60900

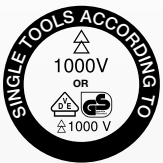

683,00
EUR

1 x		3/8"
1 x		3/8": 125 mm
5 x		3/8": 8 - 10 - 13 - 17 - 19 mm
4 x		3/8": 4 - 5 - 6 - 8 mm



117.1889

3/8" INSULATED SOCKET WRENCH SET, 11 PCS

- Insulated handle to IEC 60900

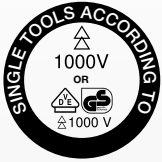

484,50
EUR



1 x		3/8"
1 x		3/8": 125 mm
5 x		3/8": 8 - 10 - 13 - 17 - 19 mm
4 x		3/8": 4 - 5 - 6 - 8 mm

117.0600

INSULATED SOCKET SET, 9 PCS, 1/2"

- In accordance to DIN 7448 / 7434 / 7449
- Insulated handle to IEC 60900

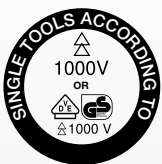

req.



1 x		270 mm
7 x		10 - 13 - 14 - 16 - 17 - 19 - 21 mm
1 x		125 mm

117.1860

INSULATED SOCKET WRENCH SET, 16 PCS, 1/2"

- Insulated handle to IEC 60900

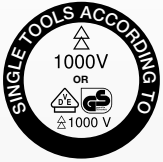

667,50
EUR

1 x		1/2"
2 x		1/2": 125 - 250 mm
1 x		1/2"
8 x		1/2": 10 - 12 - 13 - 14 - 17 - 19 - 22 - 24 mm
3 x		1/2": 5 - 6 - 8 mm
1 x		3,5 mm



117.1870

INSULATED TOOL KIT, 20 PCS

- Insulated handle to IEC 60900



635,00
EUR

1 x		205 mm
1 x		160 mm
1 x		200 mm
1 x		180 mm
1 x		160 mm
1 x		160 mm
1 x		6 - 400 V
3 x		8 - 10 - 13 mm
6 x		2,5 - 3,5 - 5,5 - 6,5 - 8,0 - 10,0 mm
2 x		PH1 - PH2
1 x		210 mm
1 x		182 mm



117.1890

TOOL SET WITH INSULATED TOOLS FOR HYBRID AND ELECTRIC VEHICLES, 43 PCS

Insulated to IEC 60900

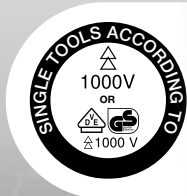

610,00
EUR



500 m

- | | | |
|--------------|--|-------------------|
| 240 mm | | T30 |
| 215 mm | | T25 |
| 210 mm | | T20 |
| 185 mm | | PH1 |
| 165 mm | | PH2 |
| 165 mm | | PH3 |
| 180 mm | | 2,5 mm |
| 10 | | 3,0 mm |
| 25 | | 3,5 mm |
| 3/8" | | 4,0 mm |
| 3/8": 150 mm | | 3/8": 6-7-8-9-10- |
| 3/8": 250 mm | | 11-12-13-14-16- |
| | | 17-18-19-20-22 mm |
| | | 3/8": M8 |
| | | 3/8": M10 |
| | | 3/8": M12 |

117.1840

**INSULATED TOOL SET,
26 PCS**

- Insulated handle to IEC 60900

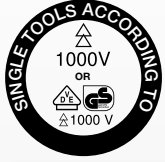

1 x		205 mm
1 x		160 mm
1 x		200 mm
1 x		1/2"
1 x		250 mm
1 x		210 mm
1 x		182 mm
7 x		10 - 11 - 12 - 13 - 14 - 17 - 19 mm
7 x		10 - 11 - 12 - 13 - 14 - 17 - 19 mm
1 x		6 - 400 V
4 x		3,5 - 5,5 - 6,5 - 8,0 mm

869,00
EUR



**RELAXED
WORK UNDER
HIGH TENSION**

TOOL TROLLEY WITH PROTECTIVE INSULATED TOOLS

117.6155

PERFORMANCE PLUS WORKSHOP TROLLEY E10 WITH 164 INSULATED TOOLS FOR ELECTRIC AND HYBRID VEHICLES



Delivery completely assembled and equipped. Including barrier post set, signs and personal protective equipment. Exact Equipment see next doublesite.





DUO Lock ingenious locking system



7 drawers each of which can carry 50 kg



Stable **ball bearing**



Stainless steel surface



Lockable **lock**



Antistatic castors with brake



Integrated **edge protection**



Paper roll holder included



Can holder included

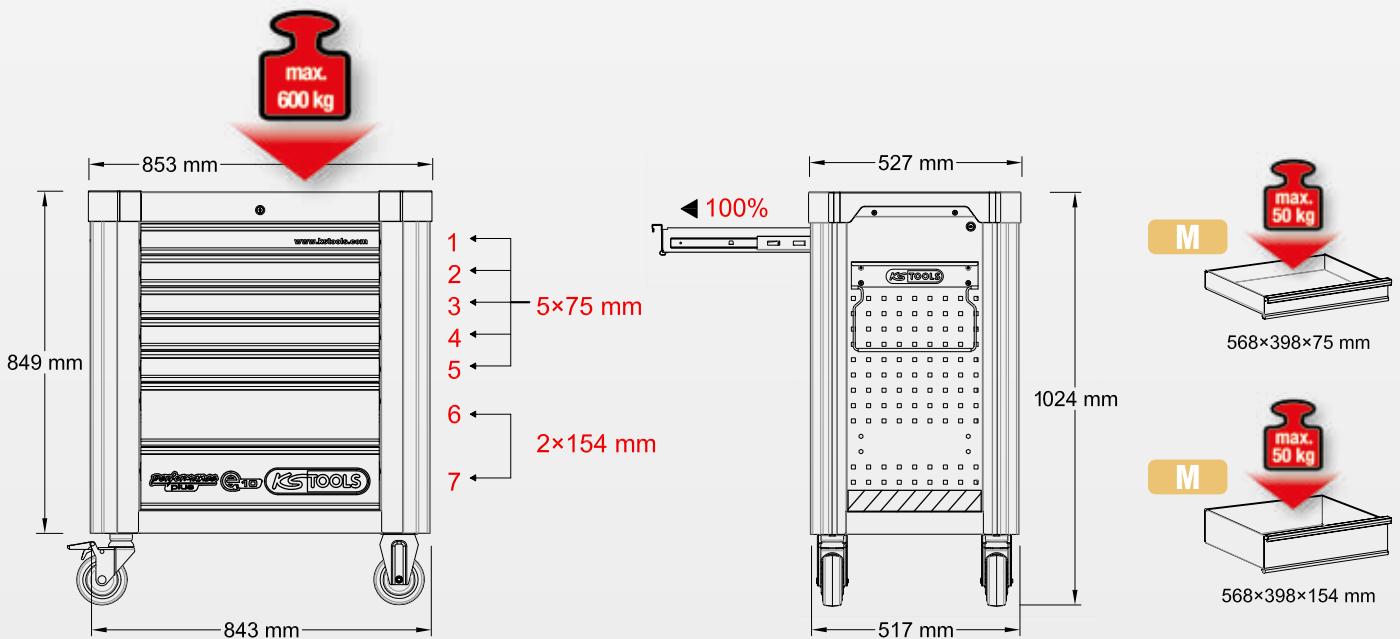

117.6155

E10 VDE SPECIAL – A COMPLETE WORKPLACE FOR ELECTRICAL AND HYBRID VEHICLES



**FULLY EQUIPPED WITH
164 INSULATED TOOLS
INCLUDING BARRIER POST SET,
SIGNS AND PERSONAL
PROTECTIVE EQUIPMENT**

**4.640,50
EUR**

Set of bollards with chain, 13 pcs

- Ideal for cordoning off areas with restricted access
- the base can be filled with sand for safe standing
- Barrier post height approx. 850 mm with 4 eyes for hanging the chain
- Including base, hook and 20 m chain
- Made from plastic



Under gloves



Electrician's face shield, classes 2



Glove for electricians with protective insulation, white

Size 10
Classes 0

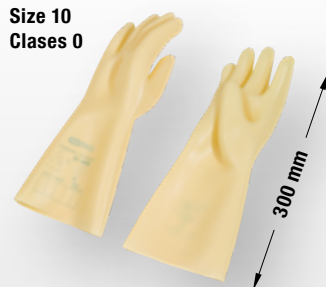

3/8" + 1/2" Isolated socket wrench set with torque wrench



- 3/8"** 6-22 mm 150+250 mm
- 1/2"** 10-32 mm 125+250 mm
- ★ T10-T55 x 60 mm
- ★ T10-T55 x 122 mm
- 4-10 mm x 60 mm
- 4-10 mm x 122 mm
- M8-M10-M12
- 3/8"+1/2"

ERGOTORQUE VDE Pliers Set



Isolated key set



- 7 - 8 - 9 - 10 - 11 - 12 - 13 - 14 - 15 - 16 - 17 - 18 - 19 - 20 - 21 - 22 - 23 - 24 mm
- 7 - 8 - 9 - 10 - 11 - 12 - 13 - 14 - 15 - 16 - 17 - 18 - 19 - 22 - 24 mm

ERGOTORQUE VDE Screwdriver Set

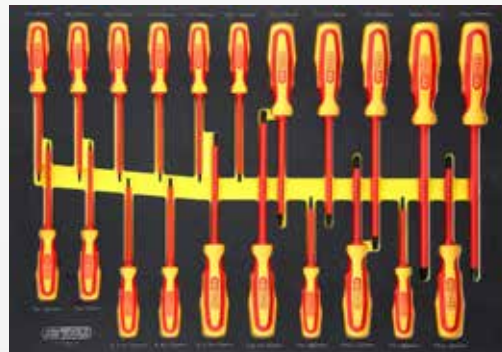

- 3,5-4-5,5-6,5 mm
- ★ T5-T6-T7-T8-T9-T10-T15-T20-T25-T27-T30-T40-T45
- ⊕ PH1 - PH2
- ⊗ PZ1 - PZ2

Warning sign hybrid switch, Ø 200 mm



Ø 200 mm

Warning sign-hybrid flash



200 mm

Isostand mat, 1,000 mm

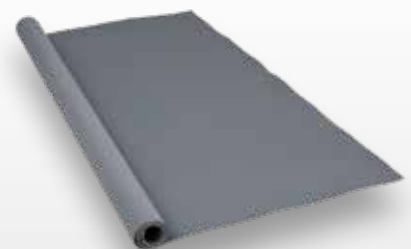

3/8"+1/2" INSULATED SOCKET SPANNER SET WITH TORQUE WRENCH IN FOAM INSERT



568 x 398

Pos.	Item No.	Description	Amount
1	118.1213	1/2" Insulated socket, 13 mm	1
2	118.1214	1/2" Insulated socket, 14 mm	1
3	118.1215	1/2" Insulated socket, 15 mm	1
4	118.1216	1/2" Insulated socket, 16 mm	1
5	118.1217	1/2" Insulated socket, 17 mm	1
6	118.1218	1/2" Insulated socket, 18 mm	1
7	118.1219	1/2" Insulated socket, 19 mm	1
8	118.1220	1/2" Insulated socket, 20 mm	1
9	118.1221	1/2" Insulated socket, 21 mm	1
10	118.1222	1/2" Insulated socket, 22 mm	1
11	118.1224	1/2" Insulated socket, 24 mm	1
12	118.1227	1/2" Insulated socket, 27 mm	1
13	118.1230	1/2" Insulated socket, 30 mm	1
14	118.1232	1/2" Insulated socket, 32 mm	1
15	118.1210	1/2" Insulated socket, 10 mm	1
16	118.1211	1/2" Insulated socket, 11 mm	1
17	118.1212	1/2" Insulated socket, 12 mm	1
18	118.3864	3/8" Insulated bit socket for hexagon socket, 4 mm, 60 mm long	1
19	118.3865	3/8" Insulated bit socket for hexagon socket, 5 mm, 60 mm long	1

Pos.	Item No.	Description	Amount
20	118.3866	3/8" Insulated bit socket for hexagon socket, 6 mm, 60 mm long	1
21	118.3868	3/8" Insulated bit socket for hexagon socket, 8 mm, 60 mm long	1
22	118.3869	3/8" Insulated bit socket for hexagon socket, 10 mm, 60 mm long	1
23	118.3810	3/8" Insulated bit socket for Torx, T10, 60 mm	1
24	118.3811	3/8" Insulated bit socket for Torx, T15, 60 mm	1
25	118.3812	3/8" Insulated bit socket for Torx, T20, 60 mm	1
26	118.3813	3/8" Insulated bit socket for Torx, T25, 60 mm	1
27	118.3814	3/8" Insulated bit socket for Torx, T27, 60 mm	1
28	118.3815	3/8" Insulated bit socket for Torx, T30, 60 mm	1
29	118.3816	3/8" Insulated bit socket for Torx, T40, 60 mm	1
30	118.3817	3/8" Insulated bit socket for Torx, T45, 60 mm	1
31	118.3818	3/8" Insulated bit socket for Torx, T50, 60 mm	1
32	118.3819	3/8" Insulated bit socket for Torx, T55, 60 mm	1
33	118.3847	3/8" Insulated socket, 22 mm	1
34	118.3845	3/8" Insulated socket, 20 mm	1
35	118.3844	3/8" Insulated socket, 19 mm	1
36	118.3843	3/8" Insulated socket, 18 mm	1
37	118.3842	3/8" Insulated socket, 17 mm	1

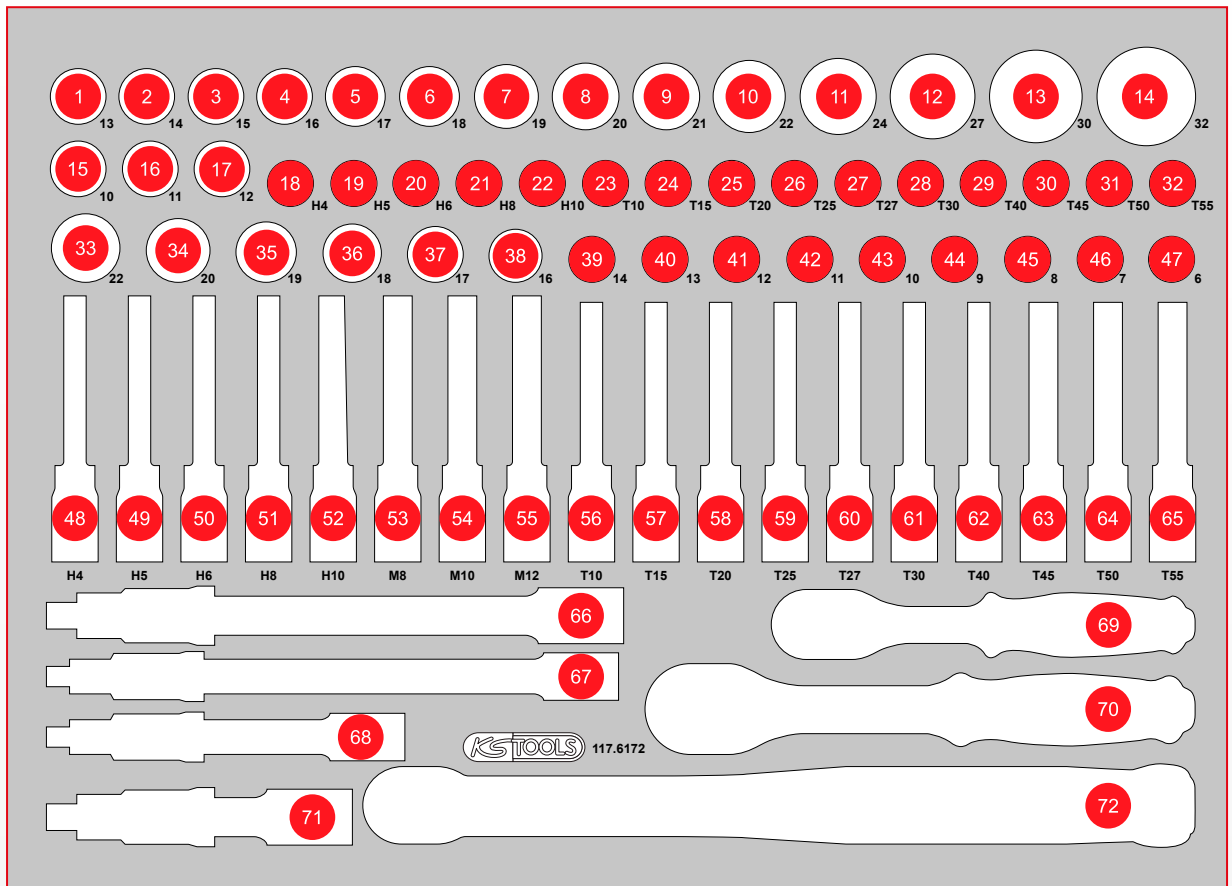

Pos.	Item No.	Description	Amount
38	118.3841	3/8" Insulated socket, 16 mm	1
39	118.3839	3/8" Insulated socket, 14 mm	1
40	118.3838	3/8" Insulated socket, 13 mm	1
41	118.3837	3/8" Insulated socket, 12 mm	1
42	118.3836	3/8" Insulated socket, 11 mm	1
43	118.3835	3/8" Insulated socket, 10 mm	1
44	118.3834	3/8" Insulated socket, 9 mm	1
45	118.3833	3/8" Insulated socket, 8 mm	1
46	118.3832	3/8" Insulated socket, 7 mm	1
47	118.3831	3/8" Insulated socket, 6 mm	1
48	118.3871	3/8" Insulated bit socket for hexagon socket, 4 mm, 122 mm long	1
49	118.3872	3/8" Insulated bit socket for hexagon socket, 5 mm, 122 mm long	1
50	118.3873	3/8" Insulated bit socket for hexagon socket, 6 mm, 122 mm long	1
51	118.3874	3/8" Insulated bit socket for hexagon socket, 8 mm, 122 mm long	1
52	118.3876	3/8" Insulated bit socket for hexagon socket, 10 mm, 122 mm long	1
53	118.3893	3/8" Insulated bit socket for spline, M8, insulated	1

Pos.	Item No.	Description	Amount
54	118.3894	3/8" Insulated bit socket for spline, M10, insulated	1
55	118.3895	3/8" Insulated bit socket for spline M12, insulated	1
56	118.3820	3/8" Insulated bit socket for Torx, T10, 122 mm	1
57	118.3821	3/8" Insulated bit socket for Torx, T15, 122 mm	1
58	118.3822	3/8" Insulated bit socket for Torx, T20, 122 mm	1
59	118.3823	3/8" Insulated bit socket for Torx, T25, 122 mm	1
60	118.3824	3/8" Insulated bit socket for Torx, T27, 122 mm	1
61	118.3825	3/8" Insulated bit socket for Torx, T30, 122 mm	1
62	118.3826	3/8" Insulated bit socket for Torx, T40, 122 mm	1
63	118.3827	3/8" Insulated bit socket for Torx, T45, 122 mm	1
64	118.3828	3/8" Insulated bit socket for Torx, T50, 122 mm	1
65	118.3829	3/8" Insulated bit socket for Torx, T55, 122 mm	1
66	118.1250	1/2" Insulated extension, 250 mm	1
67	118.3852	3/8" Insulated extension, 250 mm	1
68	118.3851	3/8" Insulated extension, 150 mm	1
69	118.3800	3/8" Insulated reversible ratchet, 72-teeth	1
70	118.1290	1/2" Insulated reversible ratchet, 32-teeth	1
71	118.1225	1/2" Insulated extension, 125 mm	1
72	118.3850	3/8" Insulated torque wrench, 5 - 50 Nm	1

INSULATED SPANNER SET IN FOAM INSERT IN FOAM INSERT

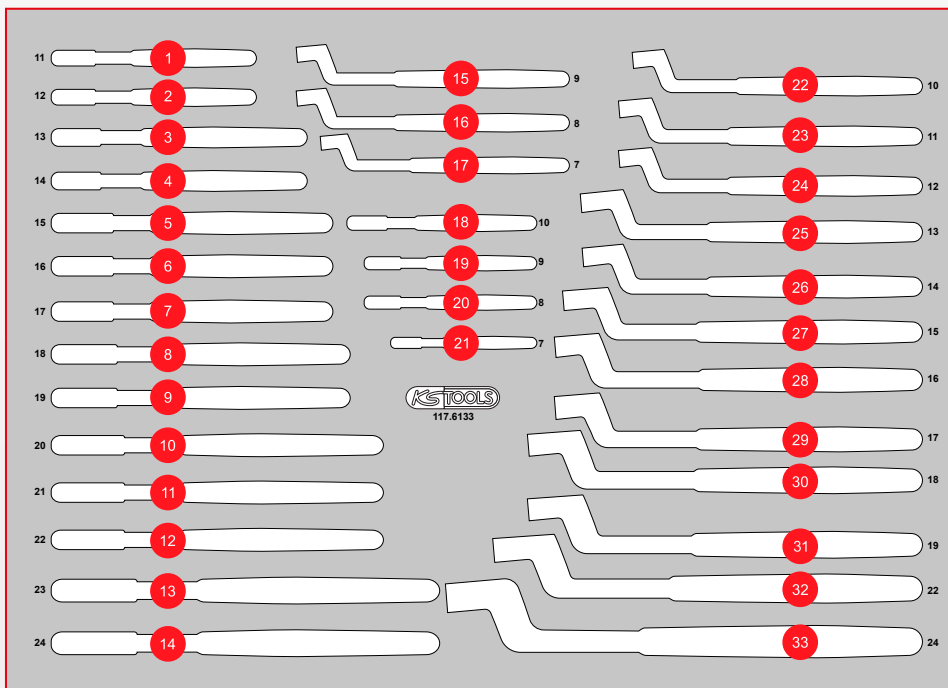

Pos.	Item No.	Description	Amount
1	118.1511	Insulated open-ended spanner, 11 mm	1
2	118.1512	Insulated open-ended spanner, 12 mm	1
3	118.1513	Insulated open-ended spanner, 13 mm	1
4	118.1514	Insulated open-ended spanner, 14 mm	1
5	118.1515	Insulated open-ended spanner, 15 mm	1
6	118.1516	Insulated open-ended spanner, 16 mm	1
7	118.1517	Insulated open-ended spanner, 17 mm	1
8	118.1518	Insulated open-ended spanner, 18 mm	1
9	118.1519	Insulated open-ended spanner, 19 mm	1
10	118.1520	Insulated open-ended spanner, 20 mm	1
11	118.1521	Insulated open-ended spanner, 21 mm	1
12	118.1522	Insulated open-ended spanner, 22 mm	1
13	118.1523	Insulated open-ended spanner, 23 mm	1
14	118.1524	Insulated open-ended spanner, 24 mm	1
15	118.1309	Insulated ring spanner, offset, 9 mm	1
16	118.1308	Insulated ring spanner, offset, 8 mm	1
17	118.1307	Insulated ring spanner, offset, 7 mm	1
18	118.1510	Insulated open-ended spanner, 10 mm	1
19	118.1509	Insulated open-ended spanner, 9 mm	1
20	118.1508	Insulated open-ended spanner, 8 mm	1
21	118.1507	Insulated open-ended spanner, 7 mm	1
22	118.1310	Insulated ring spanner, offset, 10 mm	1
23	118.1311	Insulated ring spanner, offset, 11 mm	1
24	118.1312	Insulated ring spanner, offset, 12 mm	1
25	118.1313	Insulated ring spanner, offset, 13 mm	1
26	118.1314	Insulated ring spanner, offset, 14 mm	1
27	118.1315	Insulated ring spanner, offset, 15 mm	1
28	118.1316	Insulated ring spanner, offset, 16 mm	1
29	118.1317	Insulated ring spanner, offset, 17 mm	1
30	118.1318	Insulated ring spanner, offset, 18 mm	1
31	118.1319	Insulated ring spanner, offset, 19 mm	1
32	118.1322	Insulated ring spanner, offset, 22 mm	1
33	118.1324	Insulated ring spanner, offset, 24 mm	1

ERGOTORQUE VDE SCREWDRIVER SET IN FOAM INSERT

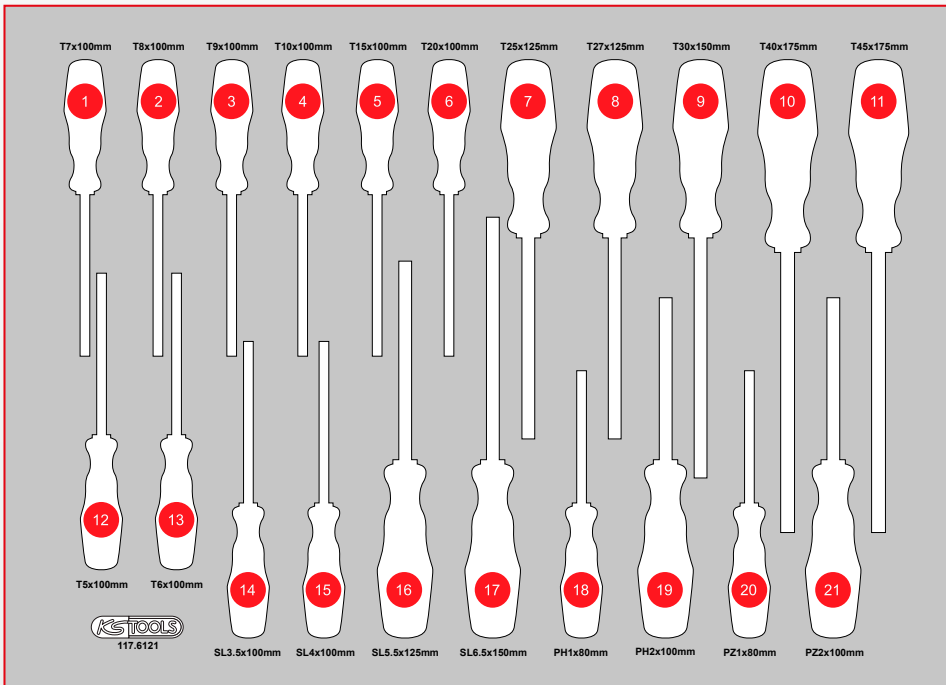
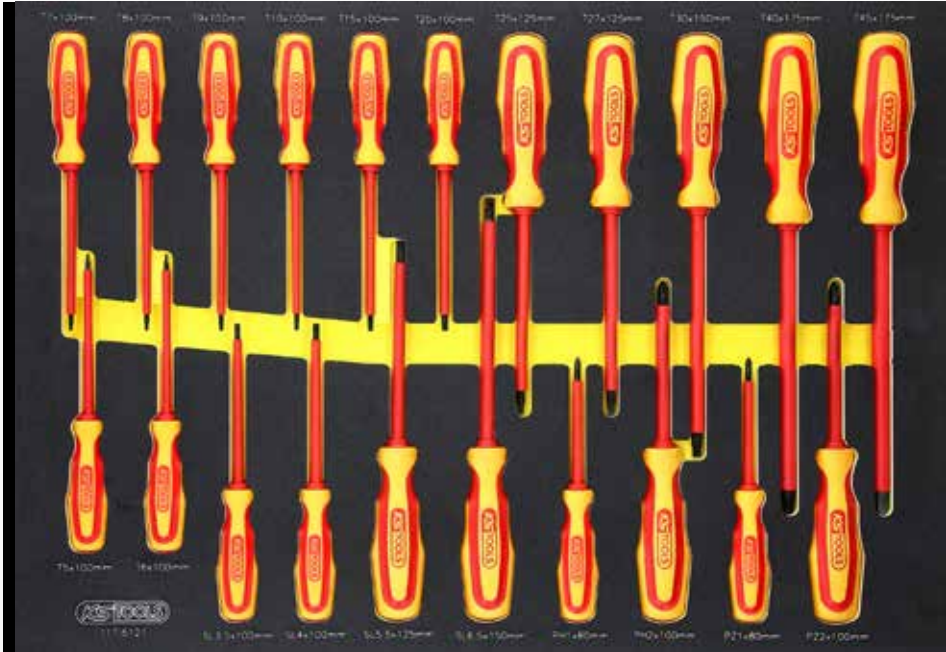

Pos.	Item No.	Description	Amount
1	117.2237	Insulated screwdriver for internal Torx screws, T7	1
2	117.2238	Insulated screwdriver for internal Torx screws, T8	1
3	117.2239	Insulated screwdriver for internal Torx screws, T9	1
4	117.0551	Insulated screwdriver for internal Torx screws, T10	1
5	117.0552	Insulated screwdriver for internal Torx screws, T15	1
6	117.0553	Insulated screwdriver for internal Torx screws, T20	1
7	117.0554	Insulated screwdriver for internal Torx screws, T25	1
8	117.0555	Insulated screwdriver for internal Torx screws, T27	1
9	117.0556	Insulated screwdriver for internal Torx screws, T30	1
10	117.0557	Insulated screwdriver for internal Torx screws, T40	1
11	117.0558	Insulated screwdriver for internal Torx screws, T45	1
12	117.2235	Insulated screwdriver for internal Torx screws, T5	1
13	117.2236	Insulated screwdriver for internal Torx screws, T6	1
14	117.0506	ERGOTORQUE VDE Slot screwdriver, 3,5 mm	1
15	117.0508	ERGOTORQUE VDE Slot screwdriver, 4 mm	1
16	117.0512	ERGOTORQUE VDE Slot screwdriver, 5,5 mm	1
17	117.0514	ERGOTORQUE VDE Slot screwdriver, 6,5 mm	1
18	117.0524	ERGOTORQUE VDE PHILLIPS screwdriver, PH1	1
19	117.0526	ERGOTORQUE VDE PHILLIPS screwdriver, PH2	1
20	117.0534	ERGOTORQUE VDE POZIDRIVE screwdriver, PZ1	1
21	117.0536	ERGOTORQUE VDE POZIDRIVE screwdriver, PZ2	1

ERGOTORQUE VDE PLIERS SET IN FOAM INSERT



Pos.	Item No.	Description	Amount
1	118.4235	Insulated protective sleeve with clamp cap, 10 mm, L=100 mm	1
2	118.4237	Insulated protective sleeve with clamp cap, 25 mm, L=100 mm	1
3	117.1630	Inspection mirror with protective insulation, 22 mm, 175 mm	1
4	117.1123	ERGOTORQUE VDE cable cutter, 215 mm	1
5	117.1118	ERGOTORQUE VDE long nose pliers, straight, 215 mm	1
6	117.1119	ERGOTORQUE VDE diagonal side cutter, 160 mm	1
7	117.1644	Plastic flat nose pliers with protective insulation, large, 160 mm	1
8	117.1643	Plastic flat nose pliers with protective insulation, small, 80 mm	1
9	117.2322	Flexible solenoid lifter with protective insulation, 250 g	1
10	117.2000	ERGOTORQUE VDE water pump pliers, 240 mm	1
11	117.1114	ERGOTORQUE VDE wire stripper, 160 mm	1
12	117.1111	ERGOTORQUE VDE combination pliers, 170 mm	1
13	117.1115	ERGOTORQUE VDE diagonal side cutter, 190 mm	1
14	118.1394	Insulated cutting knife, 180 mm	1
15	117.1126	Soft-head hammer with protective insulation, head Ø 25 mm	1
16	117.4267	Plastic expansion wedge, 160 mm	1
17	117.1503	Tension tester with protection insulation two-pole 12-1000 V	1

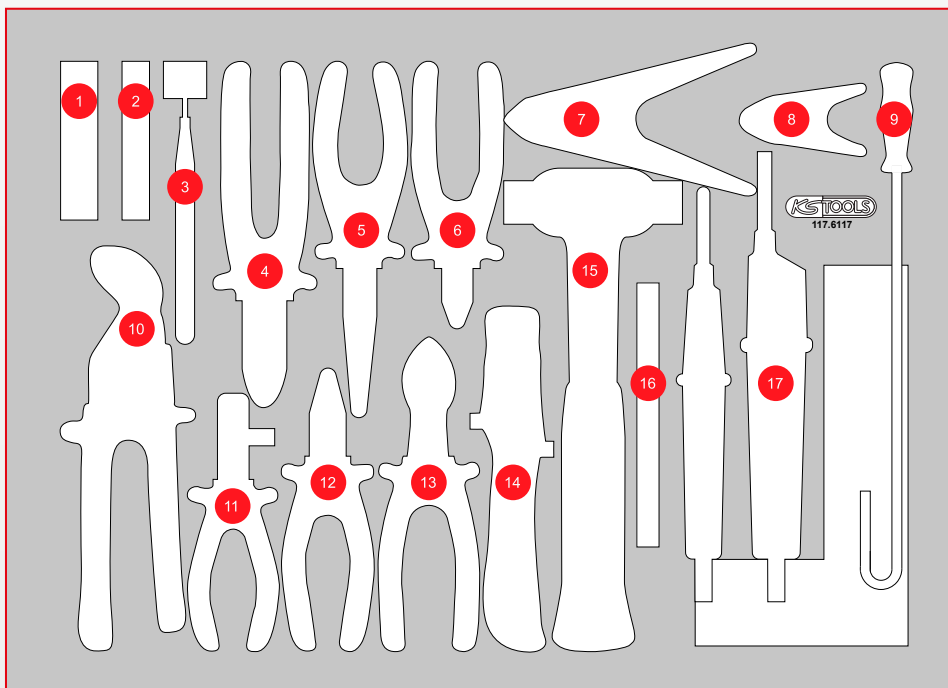

LIFTING TECHNOLOGY

117.0207

LIFTING DEVICE FOR BATTERIES

- Insulation voltage AC 1000 V and DC 1500 V
- adjustable center distance from 45 – 120 mm
- with 3 pairs of insulating screws (M8, M10 and M12)
- loadable with max. 200 Kg with M8 screws
- loadable with max. 400 Kg with M10 screws
- loadable with max. 500 Kg with M12 screws

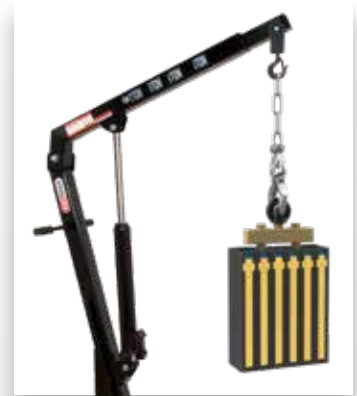

924,00
EUR

	L mm	B mm	H mm
117.0207	150	136	30

460.5525

HYDRAULIC DEPOSIT TABLE, MOBILE, 450 KG

- Ergonomic and back-friendly work due to lifting of the platform by hydraulic foot pump
- Stepless drain valve with sensitive manual lowering



req.

Technical data:
Loading area: 850 x 500 mm

	max. Load capacity Kg	min. Lifting height mm	max. Lifting height mm	Length mm	max Height mm
460.5525	450,0	280,0	860,0	880,0	945,0



We simply
electrify
your car.

- **So that you can enjoy driving it on the road.**

● Electricity to go, please.

We looked at what the vast majority of people with electric cars or plug-in hybrids really need when it comes to charging and what they don't. efuturo concentrates on the important things and does it outstandingly well.

Simply let rip

For most people, the switch to an e-mobility vehicle has a sense of change. We don't want this pleasant feeling to turn into a headache thinking about the best charging solution. Instead, we guide you right to the perfect product for you and do everything to ensure it is up and running for you in no time.

Simply complete

Wallbox, mobile charging station and charging cables: efuturo has everything you need. For charging at home, at your business or at public charging points. Including accessories and all the support you'll ever need during installation.

Simply reliable

E-mobility is developing dynamically. In order to underline their importance, we at KS Tools created our own product brand: efuturo. Their team combines the mentality of a start-up with the solid basis of our company: almost 30 years of experience, 350 employees and over 47,000 products from the world of mobility.

The illustration shows special equipment: design frame and column

...
Simply
simple



New here?

Charging expert in 120 seconds

Type 1 or type 2?

This refers to the type of plug. Type 2 is generally widely used at charging stations. Both types are used in vehicles.

E-mobile or plug-in hybrid?

efuturo has the solution for both. This also makes efuturo a good choice for the future, if you're driving a hybrid today and a fully-electric vehicle later down the line.

Type 1 charging plug

This is most commonly used in vehicles from the Far East, but it is becoming less common. Always single phase, with a maximum charging capacity 7.4 kW.

Type 2 charging plug

Now the common standard in Europe which is becoming more widely used. Single or three phase, with a maximum charging capacity 22 kW. The type 2 plug is likely to be the right type for your vehicle too. If in doubt, consult your dealer.

Mode 2 or 3?

This refers to the standard by which the vehicle and charging station communicate via the charging cable. Mode 2 is typical for mobile charging solutions and mode 3 is for stationary solutions. This is the case at efuturo too. So, when you're making a decision, you don't need to pay special attention to this criteria.

Charging times compared:

This is how long it takes to fully charge a VW ID.3 [5.8 kWh]

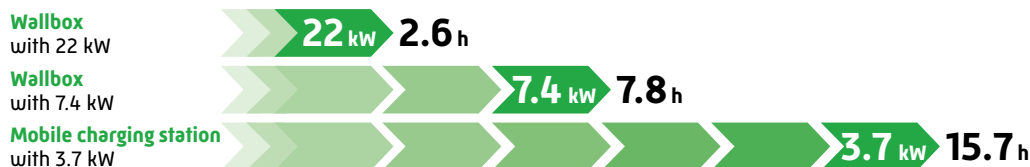

Wallbox or mobile charger?

Both have their benefits for at-home charging. Our advice? If your electricity connection supports it, go for the powerful wallbox. Even if your current vehicle cannot take advantage of the wallbox's full charging capacity, the situation is likely to be different with your next vehicle or the one after that.

Pro wallbox

- + Power up to 22 kW for faster charging
- + Convenient, neat, with no unnecessary risk of tripping over cables

Pro mobile charger

- + Connects to a normal 230 V earthed socket without the need for installation by an electrician
- + Can be stored in the boot – a reassuring backup for fully-electric vehicles in particular

And Tesla?

Tesla operates its own public charging network called Supercharger and uses its own type of plug. It is not usually possible to implement this type of fast charging station using a private domestic connection. This is why Tesla vehicles are also equipped with a charging socket for the common type 2 plug, and why Tesla and efuturo complement each other so perfectly.

Voltage, wattage and phases?

Buildings have cables with a single-phase 230 V alternating current – the exact capacity of a normal (earthed) socket. There are also cables with a three-phase alternating current and 400 V, often referred to as power current or three-phase current. Single-phase cables have a capacity of up to 7.4 kW, and three-phase cables up to 22 kW. It goes without saying that the greater the kW, the quicker the battery reaches full charge. Your electrician can tell you which cables and power capacities are available in your garage or carport.

Private or public?

Regardless of whether your car requires a type 1 or type 2 plug, all efuturo charging cables come fitted with a type 2 power plug. And it works with all efuturo wallboxes with a socket and with the vast majority of public charging stations throughout Europe.

You can find more background information at [efuturo.de](https://www.efuturo.de)





With efuturo
anything is
possible

efuturo® station one
with 3.7 and 7.4 kW
for 230 V

efuturo® station tripower
with 11 and 22 kW
for 400 V

efuturo® universal
Mobile charging stations
with 3.7 kW for 230 V

efuturo® link
Charging cables for private
and public charging stations

Type 1 charging plug



With charging socket, also compatible with type 1 charging cable

Type 2 charging plug



Built-in type 2 charging cable



With charging socket, also compatible with type 2 charging cable

Pages 162-165



Built-in type 2 charging cable



With charging socket, also compatible with type 2 charging cable

Pages 166-169



Pages 176-179



Pages 180-185



- That's efuturo ...
- What's so special about efuturo wallboxes ...
- Vertical columns and other accessories ...**
- Wallboxes compared ...
- Installation and service ...
- Warranty ...

- Page 152**
- Page 158**
- Page 170**
- Page 172**
- Page 174**
- Page 186**

Simply
inexpensive



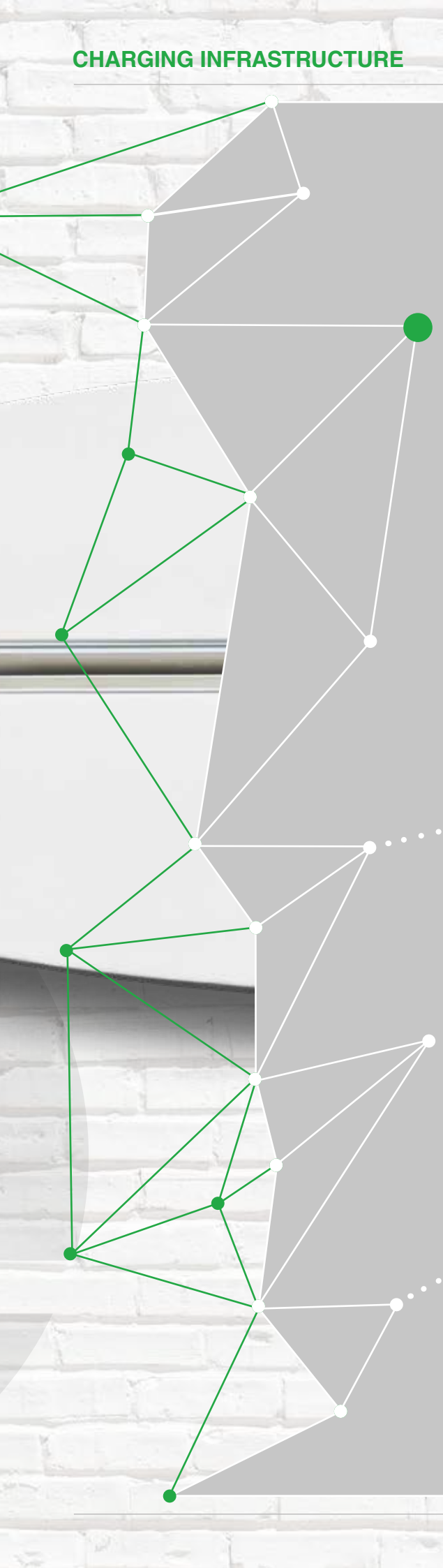

For all those who have interests other than the wallbox

Do you want to spend time with your wallbox or just get out on the road and start living? If that's the case, you probably don't want an unnecessary amount of your budget to be screwed to the wall. This reflects well on you. And on efuturo.

• Favourable conditions

At KS Tools the developers are used to harmonizing ergonomics, cost efficiency and suitability for everyday use. Nobody could show us better than regular customers in over 130 countries around the world: Practice alone counts. This maxim of our company also characterizes the efuturo wall boxes.

• Cost-effective assembly

Until now, a compact structure has meant an awkward assembly. The efuturo wallboxes are different. They are constructed in such a way that your electrician can have everything ready easily, quickly and therefore cost-effectively. Giving you more chance to enjoy the elegant light appearance of your efuturo.

• Cost-effective prerequisites

As part of the KS Tools family, our developers are accustomed to harmonising ergonomics, cost-effectiveness and ease of everyday use. Nobody could demonstrate this to us better than our regular customers in over 130 countries around the world: experience is the only thing that matters. The motto of our company group is also reflected in efuturo wallboxes.

● Everything inside. Except for hidden costs.

A low price is only low if it passes the test of a second pair of eyes. Like with efuturo.

Fair safety

People need to be protected wherever electricity flows. Especially where there is a lot of electricity, like with a wallbox. The fuse that you know from your fuse box at home is not enough. The so-called type B ground fault circuit interrupter provides optimum protection. efuturo wallboxes already come with this high-quality protection as standard, meaning there are no nasty surprises when you receive your electrician's invoice: no additional costs for an expensive external ground fault circuit interrupter, no additional effort for installation in a switch cabinet.

Fair operating life

Although efuturo does forego some special functions for special users, it never foregoes maximum quality and exceptional robustness.

Fair ease of repair

If a component ever fails, only this component needs to be replaced – not the whole board.

Simply fair



WALLBOXES

Single-phase, simply good

Even if only a single-phase electricity connection with 230 V is available, a built-in station on the wall or column is worthwhile. Because, unlike a mobile charging station, you can use various convenient and performance features.

These include an access control with a chip card or an integrated electricity meter, both of which are optional extras. The efuturo wallbox always includes a high-quality type B ground fault circuit interrupter as standard.

The built-in type 2 cable with a length of 5 meters is also of the highest quality. Particularly practical: after charging, you can hang the plug in the integrated holder on the front. Or you can opt for the supplied, separate wall holder, which you can attach at the most convenient location for you.

efuturo® station one 3,7



efuturo® station one 7,4



	efuturo® station one 3,7		efuturo® station one 7,4	
	Charge after 1 h	100 % charged	Charge after 1 h	100 % charged
Wallbox	117.7534 req.		117.7574 993,50 EUR	
access control included	117.7533 1.039,00 EUR		117.7573 1.028,00 EUR	
electricity meter included	117.7532 1.097,50 EUR		117.7572 1.097,50 EUR	
access control and electricity meter included	117.7531 1.120,50 EUR		117.7571 1.120,50 EUR	
VW ID.3 [58 kWh]	6.4 %	15.7 h	12.8 %	7.4 h
Tesla 3 [58 kWh]	6.4 %	15.7 h	12.8 %	7.4 h
Renault ZOE [52 kWh]	7.1 %	14.0 h	14.2 %	7.0 h

The efuturo[®] station one

Optional electricity meter:

Ideal for example if a tenant and landlord want to separate costs clearly. To read the meter, switch off the electricity supply and open the housing in a few easy steps. The LCD display then shows you the consumption in kWh. Calibrated according to the European MID norm.



Optional access control:

Even though the efuturo has lots of fans, only those with a chip card can charge up.



START FROM **993,50** EUR

Integrated holder

Let the charging plug dangle loosely or hang it in? You have the choice.



Fact check

- charging station for wall or column mounting
- integrated, high-quality five-metre cable, type 2 plug, mode 3
- can be installed by an electrician on a single-phase domestic connection with 230 V
- integrated type B ground fault circuit interrupter
- overheating protection
- compact construction but still easy to assemble
- robust plastic housing, also suitable for use outdoors

Vertical columns and other accessories from page **170**

Further technical data on page **172**

The efuturo[®] station one with a charging socket

Optional access control

You can only charge up when you hold your contactless card to the efuturo.



Optional electricity meter

Whether you're watching your own finances or billing on behalf of the community, the integrated meter with LCD display helps you along your way. To read the meter, switch off the electricity supply and open the housing in a few easy steps. Consumption displayed in kWh, calibrated according to the European MID norm.



Fact check

- charging station for wall or column mounting
- charging socket for cable with type 2 plug, mode 3
- can be installed by an electrician on a single-phase domestic connection with 230 V
- integrated type B ground fault circuit interrupter
- overheating protection
- compact construction but still easy to assemble
- robust plastic housing, also suitable for use outdoors

START FROM **1.016,50** EUR

With a socket. And a large dose of freedom.

With this efuturo wallbox, [almost] anything is possible. All you need is a single-phase electricity connection with 230 V, and your personal cable with type 2 connection also fits into the socket. This can, for example, be a cable for a type 1 plug on a vehicle.

You have free rein when it comes to choosing the optional extras: Possible options include access control via chip card and an integrated electricity meter.

And without being asked, we have included optimum value for money, the best possible ease of assembly, quality and longevity at the lowest price.



Vertical columns and other accessories from page **170**

Further technical data on page **172**

efuturo® station one 3,7 with charging socket type 2

Input 230 V single-phase 16 A → Output **3.7 kW**

efuturo® station one 7,4 with charging socket type 2

Input 230 V single-phase 32 A → Output **7.4 kW**

- Wallbox
- access control included
- electricity meter included
- access control and electricity meter included

117.7539	1.016,50 EUR
117.7538	1.039,00 EUR
117.7537	1.097,50 EUR
117.7536	req.

117.7579	1.016,50 EUR
117.7578	1.039,00 EUR
117.7577	1.097,50 EUR
117.7576	req.

VW ID.3 (58 kWh)	6.4 %	15.7 h
Tesla 3 (58 kWh)	6.4 %	15.7 h
Renault ZOE (52 kWh)	7.1 %	14.0 h

Charge after 1 h	100 % charged
6.4 %	15.7 h
6.4 %	15.7 h
7.1 %	14.0 h

Charge after 1 h	100 % charged
12.8 %	7.4 h
12.8 %	7.4 h
14.2 %	7.0 h

This powerhouse delivers electricity by express

If your garage or carport can support a three-phase electricity connection (400 V and 16 or 32 A), efuturo is the perfect choice. The up to 22kW charging capacity charges your battery in no time.

The permanently installed cable, with its 5 meters length, gives you enough space for almost any installation situation. And after charging, the plug does not hang in the air, but waits in the holder on the front of the housing or on the wall for its next use.

The norm of the type 2 plug also prevents this. Since it is so universal, your efuturo will be charging many more generations of vehicles.

efuturo® station tripower 11

Input: 400 V three-phase 16 A
Output: 11 kW

efuturo® station tripower 22

Input: 400 V three-phase 32 A
Output: 22 kW

Wallbox

117.7512
1.120,50 EUR

117.7522
req.

access control included

117.7511
1.154,50 EUR

117.7521
1.154,50 EUR

VW ID.3 (58 kWh)

Charge after 1 h: 18.9 %
100 % charged: 5.3 h

Charge after 1 h: 38.5 %
100 % charged: 2.6 h

Tesla 3 (58 kWh)

Charge after 1 h: 18.9 %
100 % charged: 5.3 h

Charge after 1 h: 38.5 %
100 % charged: 2.6 h

Renault ZOE (52 kWh)

Charge after 1 h: 21.1 %
100 % charged: 4.7 h

Charge after 1 h: 42.3 %
100 % charged: 2.4 h

The efuturo[®] station tripower for three-phase connections

Optional access control

You can only charge up when you hold your contactless card to the efuturo.

Fact check

- charging station for wall or column mounting
- integrated, high-quality five-metre cable, type 2 plug, mode 3
- can be installed by an electrician on a three-phase domestic connection with 400 V
- integrated type B ground fault circuit interrupter
- overheating protection
- compact construction but still easy to assemble
- robust plastic housing, also suitable for use outdoors



Vertical columns and other accessories from page

170

Further technical data on page

172



START FROM

1.120⁵⁰ /EUR

The efuturo[®] station tripower with a charging socket

Optional access control

This is ideal, for example, at semi-public company car parks where only authorised employees are intended to charge up: the contactless access control via chip card. Available as an optional extra for every efuturo.

Order included

If you don't unplug your charging cable and take it with you, you can wrap it around the case to save space.

Fact check

- charging station for wall or column mounting
- integrated, high-quality five-metre cable, type 2 plug, mode 3
- can be installed by an electrician on a three-phase domestic connection with 400 V
- integrated type B ground fault circuit interrupter
- overheating protection
- compact construction but still easy to assemble
- robust plastic housing, also suitable for use outdoors

START FROM 1.089,00 EUR

Maximum power, maximum flexibility

Want a single cable for charging at home and at public stations? Or perhaps you want to charge up at a customer car park? Then you've come to the right place.

Because, the efuturo Wallbox tripower with charging socket does away with the integrated cable, but that's the only thing. Depending on the version, this provides 11 or 22 kW power when connected to a three-phase 400 V domestic connection.

All original efuturo charging cables from this catalogue with lengths up to 8 m, straight or coiled, with type 1 or type 2 vehicle charging plugs fit the type 2 sockets of this efuturo. Already own a type 2 cable? This fits too.



Vertical columns and other accessories from page

170

Further technical data on page

172

efuturo® station tripower 11 with charging socket type 2

Input: 400 V three-phase 16 A
Output: 11 kW

efuturo® station tripower 22 with charging socket type 2

Input: 400 V three-phase 32 A
Output: 22 kW

Wallbox

117.7514 req.

117.7524 req.

access control included

117.7513 req.

117.7523

1.271,00 EUR

VW ID.3 [58 kWh]

Charge after 1 h: 18.9 %

100 % charged: 5.3 h

Charge after 1 h: 38.5 %

100 % charged: 2.6 h

Tesla 3 [58 kWh]

Charge after 1 h: 18.9 %

100 % charged: 5.3 h

Charge after 1 h: 38.5 %

100 % charged: 2.6 h

Renault ZOE [52 kWh]

Charge after 1 h: 21.1 %

100 % charged: 4.7 h

Charge after 1 h: 42.3 %

100 % charged: 2.4 h

ACCESSORIES FOR WALLBOXES



Design frame

Owning an efuture wallbox documents a new mobility culture. Use the green design frame to make a visual statement. Or display it on your customer car park to invite people to charge up.

Compatible with all efuture wallboxes, weather-resistant plastic, simple click assembly with no need for tools.

117.7912
39,00 EUR



Vertical column mono

Simple, elegant, designed specifically for efuture: Using this column, you can position your efuture exactly where it is needed. The steel column and base plate are powder-coated to a high quality, which protects them against corrosion and makes them suitable for use outdoors.

Compatible with all efuture wallboxes, cable routing inside the column, all holes for assembly pre-drilled, colour anthracite grey RAL 7016, column dimensions H 1,200 mm x W 180 mm x D 85 mm (without wallbox), base plate W 300 x D 160 mm.

117.7921
381,50 EUR



Vertical column duo

Like the mono model, but for two wallboxes.

117.7922
381,50 EUR



Cable bracket

With efuturo you have the choice: Instead of winding the cable around the housing after charging, you can also store it on the separate wall holder. Once the charging cable has been tidied up, nobody will trip over it or drive over the plug.

Steel, painted black, including screws and wall plugs.

117.7904
33,50 EUR



45° angled version for type 2 plug

Plug bracket

Protected and within easy reach: This is how the charging plug feels most at home. Treat it to a wall bracket, leaving no risk of tripping over the cable. Plastic, black, including screws and wall plugs.



Straight version for type 1 plug

117.7901
33,50 EUR



Straight version for type 2 plug

117.7902
33,50 EUR



Electricity meter installation for efuturo® station one

Everything under control: This meter with LCD display is retrofitted into the wallbox by an electrician. To read the meter, switch off the electricity supply and open the housing in a few easy steps.

Connection 230 V single-phase up to 32 A, frequency 50 Hz, accuracy class B, MID-calibrated, pulse output 1,000 imp/kWh, temperature range -25°C to + 55°C.

117.7931
54,50 EUR



External electricity meter for efuturo® station tripower

This meter is specifically for three-phase wallboxes. It is installed by an electrician externally in the switch cabinet on the profile rail. Electricity consumption in kWh shown on the LCD display.

Connection 400 V three-phase up to 32 A, frequency 50 Hz, accuracy class B, MID-calibrated, pulse output 1,000 imp/kWh, temperature range -25°C to + 55°C.

117.7933
151,00 EUR



RFID card

Do you own an efuturo wallbox with access control but the three supplied RFID chip cards aren't enough for the many fans? The why not get some extras here? When ordering, we need your efuturo wallbox's serial number so that we can validate the card for you.

Cards to activate the charging process, credit card format, integrated RFID chip.

117.7911
req.

WALLBOXES IN COMPARISON

- As standard
- Available as accessories, see the previous page

efuturo® station
one 3,7

117.7534	117.7532	117.7533	117.7531	117.7539	117.7537	117.7538	117.7536
----------	----------	----------	----------	----------	----------	----------	----------

Electricity connection and power

Voltage [V]	230						
Alternating current phases	1						
Amperage [A]	16						
Maximum charging capacity [kW]	3,7						

Charging connection

Communication mode 3	●	●	●	●	●	●	●
Integrated charging cable, black, type 2 plug	3 G 6.0 mm ² + 1 x 0,5 mm ²						
Type 2 socket according to IEC 61851 norm				●	●	●	●

Features

Operation display via LED	●	●	●	●	●	●	●
RFID access control (including three chip cards)		●		●	●		●
Electricity meter, MID-calibrated			●	●		●	●

Safety

IP55 protection class	●	●	●	●	●	●	●
RCD type B (ground fault circuit interrupter)	●	●	●	●	●	●	●
Overheating protection	●	●	●	●	●	●	●
TÜV, CE and RoHS certification	●	●	●	●	●	●	●

Operating conditions

Suitable for use outdoors	●	●	●	●	●	●	●
Temperature range	-40°C to +45°C						
Pairing cycles	Up to 10,000						

Design

The option of wall or column mounting	●	●	●	●	●	●	●
Black plastic housing	●	●	●	●	●	●	●
Green accent frame	○	○	○	○	○	○	○
Dimensions (without cable)	W 199 x H 326 x D 132 mm						

Contents and assembly

Assembly and operation manual	●	●	●	●	●	●	●
Set for wall mounting and drilling template	●	●	●	●	●	●	●
Vertical column	○	○	○	○	○	○	○
Separate wall bracket for charging plug	●	●	●	●	○	○	○

Price

All prices exclude VAT	req.	1.097,50	1.039,00	1.120,50	1.016,50	1.097,50	1.039,00	1.089,00
------------------------	------	----------	----------	----------	----------	----------	----------	----------

**efuturo® station
one 7,4**

**efuturo® station
tripower 11**

**efuturo® station
tripower 22**

117.7574	117.7572	117.7573	117.7571	117.7579	117.7577	117.7578	117.7576	117.7512	117.7511	117.7514	117.7513	117.7522	117.7521	117.7524	117.7523
----------	----------	----------	----------	----------	----------	----------	----------	----------	----------	----------	----------	----------	----------	----------	----------

230								400				400			
1								3				3			
32								16				32			
7,4								11				22			

3 G 6.0 mm ² + 1 x 0,5 mm ²								5G 2.5 mm ² + 1 x 0.5 mm ²				5G 6.0 mm ² + 1 x 0.5 mm ²			
---	--	--	--	--	--	--	--	--	--	--	--	--	--	--	--

● ● ● ● ● ● ● ●								● ● ● ●				● ● ● ●			
● ● ● ● ● ● ● ●								○ ○ ○ ○				○ ○ ○ ○			

● ● ● ● ● ● ● ●								● ● ● ●				● ● ● ●			
● ● ● ● ● ● ● ●								● ● ● ●				● ● ● ●			
● ● ● ● ● ● ● ●								● ● ● ●				● ● ● ●			
● ● ● ● ● ● ● ●								● ● ● ●				● ● ● ●			

-40°C to +45°C								-40°C to +45°C				-40°C to +45°C			
Up to 10,000								Up to 10,000				Up to 10,000			

● ● ● ● ● ● ● ●								● ● ● ●				● ● ● ●			
○ ○ ○ ○ ○ ○ ○ ○								○ ○ ○ ○				○ ○ ○ ○			
W 199 x H 326 x D 132 mm								W 199 x H 326 x D 132 mm				W 199 x H 326 x D 132 mm			

● ● ● ● ● ● ● ●								● ● ● ●				● ● ● ●			
● ● ● ● ● ● ● ●								● ● ● ●				● ● ● ●			
○ ○ ○ ○ ○ ○ ○ ○								○ ○ ○ ○				○ ○ ○ ○			
● ● ● ● ● ● ● ●								● ● ● ●				● ● ● ●			

993,50	1.097,50	1.028,00	1.120,50	1.016,50	1.097,50	1.039,00	req.	1.120,50	1.154,50	req.	req.	req.	1.154,50	req.	1.271,00
--------	----------	----------	----------	----------	----------	----------	------	----------	----------	------	------	------	----------	------	----------

Installation and service

efuturo and the electrician: like two peas in a pod.

Done already? That was quick.

Some electricians think that compactly constructed wallboxes are inconvenient to install. efuturo is different. We listened closely to the people doing the practical work and designed efuturo to be easy to install. This reduces the work required and thus the costs for the installation.

Everything the professional needs

Instructions, drilling templates, forms for the mandatory registration of the wallbox with the energy supplier: all within easy reach.

Digital support

Do you have any questions? Or perhaps your electrician does? We offer support digitally, quickly and in person:

info@efuturo.de

The illustration shows special equipment: design frame and column





Plug and Play. And Drive.

Have you got a normal earthed socket within reach and want to get started without an electrician? Or perhaps you would like a charging solution that you can simply take with you, e.g. to friends or your holiday home?

You can still benefit from the quality and electrifying value for money that efuturo can offer. Mobile with efuturo. It can be used straight away with a type 2 charging cable. The 5.5-metre cable offers you a generous range between the earthed socket and vehicle.

Since mobile charging solutions take longer by their very nature, usually overnight, we recommend our mobile efuturo with integrated timer. You can use it to program the charging process so that you use the cheaper off-peak electricity, for example.

Nice destination
but no wallbox?
Then simply take
your own charging
power with you.





Plug into the socket and away you go!



Fact check

- mobile charging station to connect to earthed socket, 230 V, single phase
- charging cable with type 2 plug, mode 2
- power adjustable in two stages: 2.3 kW (at 10 A) or 3.7 kW (at 16 A)
- operation display via LED
- 1.5-metre earthed supply cable
- 4-metre charging cable
- overheating protection
- compact construction, takes up little space in the boot
- robust plastic housing, also suitable for use outdoors

efuturo® universal

Input
230 V
single-phase 16 A

Output max
3.7 kW

117.7605

req.

Further technical data on page

184

The mobile efuturo® with extra LCD comfort



The LCD display allows you to keep an eye on the charging time elapsed so far.



Fact check

- mobile charging station to connect to earthed socket, 230 V, single phase
- charging cable with type 2 plug, mode 2
- power adjustable in two stages: 2.3 kW (at 10 A) or 3.7 kW (at 16 A)
- see the elapsed charging time on the LCD display
- operation display via LED
- 1.5-metre earthed supply cable
- 4-metre charging cable
- overheating protection
- compact construction, takes up little space in the boot
- robust plastic housing, also suitable for use outdoors

efuturo® universal max

Input 230 V single-phase 16 A Output max 3.7 kW

117.7610
485,50
 EUR

Further technical data on page 184

The mobile efuturo® with timer

Constellation of a large e-car: Charge when electricity costs the least.

Want to charge up immediately? Or charge up at a specific time? It's your choice – and you can keep an overview of everything via the LCD display.

All mobile efuturos can be used with a standard domestic 230 V earthed socket.



Fact check

- mobile charging station to connect to earthed socket, 230 V, single phase
- charging cable with type 2 plug, mode 2
- five power settings to choose between 1.4 kW [at 6 A] and 3.7 kW [at 16 A]
- start time and duration of the charging process can be selected
- LCD display plus operation display via LED
- 1.5-metre earthed supply cable
- 4-metre charging cable
- overheating protection
- compact construction, takes up little space in the boot
- robust plastic housing, also suitable for use outdoors

efuturo®
universal pro

Input **230 V**
single-phase 16 A **Output max 3.7 kW**

117.7615

623,50
EUR

Further technical data on page

184

CHARGING CABLE

Good combination. Of price and performance too.

The power station of your energy supplier on the one hand, your e-mobility vehicle on the other. The finest high-tech times two. Their combination should ensure excellent performance. Especially on the "last metre", i.e. on the charging cable.

That is why all efuturo cables are created using the best components. This begins with the cable: Its high quality prevents unwanted drop in performance or even overheating.

And with that in mind, the plugs are robust, weather-resistant and safe. And with efuturo, the benefits are not only obvious, they are palpable, allowing you to appreciate the good ergonomics in day-to-day use.

Type 1 charging plug

This is most commonly used in vehicles from the Far East, but it is becoming less common. Always single phase, with a maximum charging capacity 7.4 kW.

Private or public? efuturo is always a good fit.

Regardless of whether your car requires a type 1 or type 2 plug, all efuturo charging cables come fitted with a type 2 power plug. And it works with all efuturo wallboxes with a socket and with the vast majority of public charging stations throughout Europe. And another thing you can count on with efuturo: When you lock your vehicle, the charging cable is also locked in place and cannot be removed.

In a nutshell

Type 2 charging plug

Now the common standard in Europe which is becoming more widely used.

Single or three phase, with a maximum charging capacity 22 kW. The type 2 plug is likely to be the right type for your vehicle too. If in doubt, consult your dealer.

Mode 3

This refers to the standard by which the vehicle and charging station communicate via the charging cable. With efuturo charging cables and mode 3, you are also up to date and on the safe side in this respect.

The efuturo® link type 1 and type 2 charging cable

START FROM 185,00 EUR

Straight cable with an open end

One end with a charging plug, one end to retrofit a fixed connection to a wallbox.



5 m



8 m

5 m

3 m

Straight cable

The classic, with plugs on both ends. Offers you the most metre for your money.

Find the right cable for you

START FROM 231,00 EUR



5 m

8 m

Coiled cable

Particularly easy to use. Once you have finished charging, the cable retracts easily and takes up little space in the boot without rolling up. When charging outdoors, the coiled cable also has little to no contact with dirt on the road or slushy snow.

START FROM 266,00 EUR



Cable bag included

Typical efuturo: surprisingly cheap – and an extra with a sense of practicality to boot. Each efuturo charging cable (except those with open ends) comes with a specially designed, robust bag with two carry handles. It keeps the boot tidy and protects it in the event the charging cable gets dirty or wet. Can also be used with our mobile charging stations. ø 400 mm.



0,00 EUR *



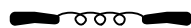

* also available individually 117.7941 39,00 EUR

The efuturo[®] cable finder



Which charging plug does your car require?

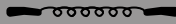

Type 1 charging plug

-  Straight cable with type 1 charging plug and type 2 power plug
-  Coiled cable with type 1 charging plug and type 2 power plug
-  Straight cable with type 1 charging plug and open end

	3.7 kW 230 V single-phase 16 A	7.4 kW 230 V single-phase 32 A
3 metres		 117.7125 231,00 EUR
5 metres	 117.7310 266,00 EUR	 117.7130 266,00 EUR  117.7330 277,50 EUR  117.7225 185,00 EUR
8 metres		 117.7135 req.

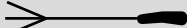
Type 2 charging plug

-  Straight cable with charging plug and type 2 power plug
-  Coiled cable with charging plug and type 2 power plug
-  Straight cable with type 2 charging plug and open end

	7.4 kW	11 kW	22 kW
	230 V single-phase 32 A	400 V three-phase 16 A	400 V three-phase 32 A
3 metres	 117.7145 231,00 EUR	 117.7165 242,50 EUR	 117.7185 277,50 EUR
5 metres	 117.7150 266,00 EUR	 117.7170 283,00 EUR	 117.7190 339,00 EUR
	 117.7345 277,50 EUR	 117.7365 277,50 EUR	 117.7385 393,00 EUR
	 117.7255 185,00 EUR	 117.7235 197,50 EUR	 117.7245 346,00 EUR
8 metres	 117.7155 323,50 EUR	 117.7175 323,50 EUR	 117.7195 404,50 EUR
	 117.7350 358,50 EUR		

Type 1 or type 2 – always on the safe side

Fact check

- charging cable for electric and hybrid vehicles according to the IEC 62196-2 norm for private and public charging stations
- high-performance cable with a cross-section of up to 5 x 6.0 mm² and 1 x 0.5 mm²
- ergonomically shaped, robust plug with protective cover
- communication mode 3
- overheating protection
- black cable and plug
- supplied with cable bag (except cables with open end)

Further technical data on the next page

All mobile charging stations compared

● As standard

○ Available as accessories, see the previous page

	efuturo® universal 117.7605	efuturo® universal max 117.7610	efuturo® universal pro 117.7615
Electricity connection and power			
Earthed socket	●	●	●
Voltage [V]	230	230	230
Alternating current phases	1	1	1
Adjustable amperage [A]	10 / 16	10 / 16	6 - 16
Maximum charging capacity [kW]	3.7	3.7	3.7
Charging connection			
Communication mode 2	●	●	●
Integrated charging cable*, black, type 2 plug**	●	●	●
Features			
LCD display to show charging time		●	●
Operation display via LED	●	●	●
Adjust the amperage [A] in stages	10 / 16	10 / 16	6 / 8 / 10 / 13 / 16
Charging start time can be preselected			●
Charging time can be selected			●
Safety			
Protection class	IP66	IP67	IP65
Overheating protection	●	●	●
TÜV, CE and RoHS certification	●	●	●
Operating conditions			
Suitable for use outdoors	●	●	●
Temperature range	-40°C to +75°C	-40°C to +75°C	-30°C to +75°C
Pairing cycles	Up to 10,000	Up to 10,000	Up to 10,000
Design			
Black plastic housing	●	●	●
Dimensions of housing [mm]	W 105 x H 245	W 105 x H 245	W 105 x H 235
Cable length [earthed] in front of housing [m]	1,500	1,500	1,500
Cable length [type 2] behind housing [mm]	4,000	4,000	4,000
Contents and accessories			
Instruction manual	●	●	●
Separate wall bracket for charging plug	○	○	○
Bag	○	○	○
Price			
All prices exclude VAT	req.	485,50	623,50

* straight high-performance cable with profile 3 G 2.5 mm² and 1 x 0.5 mm²

** according to IEC 61851 norm

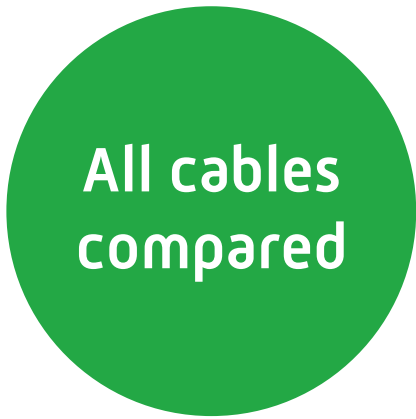

Connection and power		Safety				Operating conditions		Design and contents		Price		
Charging plug	Maximum charging capacity (kW)	Length (m)	Type 2 power plug and mode 3 communication	high-performance cable with a cross-section see table * 1 x 0.5 mm ²	IP 44 protection class (with protective cap)	Overheating protection	TUV, CE and RoHS certification	-25°C to +50°C temperature range	Up to 10,000 pairing cycles	Black cable and plug	Supplied with a bag	All prices exclude VAT
efuturo® link												
Straight cable												
117.7125	Type 1	7.4 kW at 230 V single-phase 32 A	3	●	3 G 6.0 mm ²	●	●	●	●	●	●	231,00
117.7130	Type 1	7.4 kW at 230 V single-phase 32 A	5	●	3 G 6.0 mm ²	●	●	●	●	●	●	266,00
117.7135	Type 1	7.4 kW at 230 V single-phase 32 A	8	●	3 G 6.0 mm ²	●	●	●	●	●	●	req.
117.7145	Type 2	7.4 kW at 230 V single-phase 32 A	3	●	3 G 6.0 mm ²	●	●	●	●	●	●	231,00
117.7150	Type 2	7.4 kW at 230 V single-phase 32 A	5	●	3 G 6.0 mm ²	●	●	●	●	●	●	266,00
117.7155	Type 2	7.4 kW at 230 V single-phase 32 A	8	●	3 G 6.0 mm ²	●	●	●	●	●	●	323,50
117.7165	Type 2	11 kW at 400 V three-phase 16 A	3	●	5 G 2.5 mm ²	●	●	●	●	●	●	242,50
117.7170	Type 2	11 kW at 400 V three-phase 16 A	5	●	5 G 2.5 mm ²	●	●	●	●	●	●	283,00
117.7175	Type 2	11 kW at 400 V three-phase 16 A	8	●	5 G 2.5 mm ²	●	●	●	●	●	●	323,50
117.7185	Type 2	22 kW at 400 V three-phase 32 A	3	●	5 G 6.0 mm ²	●	●	●	●	●	●	277,50
117.7190	Type 2	22 kW at 400 V three-phase 32 A	5	●	5 G 6.0 mm ²	●	●	●	●	●	●	339,00
117.7195	Type 2	22 kW at 400 V three-phase 32 A	8	●	5 G 6.0 mm ²	●	●	●	●	●	●	404,50
efuturo® flexible link												
Coiled cable												
117.7310	Type 1	3.7 kW at 230 V single-phase 16 A	5 (idle 3)	●	3 G 2.5 mm ²	●	●	●	●	●	●	266,00
117.7330	Type 1	7.4 kW at 230 V single-phase 32 A	5 (idle 3)	●	3 G 6.0 mm ²	●	●	●	●	●	●	277,50
117.7345	Type 2	7.4 kW at 230 V single-phase 32 A	5 (idle 3)	●	3 G 6.0 mm ²	●	●	●	●	●	●	277,50
117.7350	Type 2	7.4 kW at 230 V single-phase 32 A	8 (idle 5)	●	3 G 6.0 mm ²	●	●	●	●	●	●	358,50
117.7365	Type 2	11 kW at 400 V three-phase 16 A	5 (idle 3)	●	5 G 2.5 mm ²	●	●	●	●	●	●	277,50
117.7385	Type 2	22 kW at 400 V three-phase 32 A	5 (idle 3)	●	5 G 6.0 mm ²	●	●	●	●	●	●	393,00
efuturo® link												
Straight cable with open end												
117.7225	Type 1	7.4 kW at 230 V single-phase 32 A	5	●	3 G 6.0 mm ²	●	●	●	●	●	●	185,00
117.7255	Type 2	7.4 kW at 230 V single-phase 32 A	5	●	3 G 6.0 mm ²	●	●	●	●	●	●	185,00
117.7235	Type 2	11 kW at 400 V three-phase 16 A	5	●	5 G 2.5 mm ²	●	●	●	●	●	●	197,50
117.7245	Type 2	22 kW at 400 V three-phase 32 A	5	●	5 G 6.0 mm ²	●	●	●	●	●	●	346,00

- Thanks to you, e-mobility is on an upward trend.

Even more future – with 5 years warranty!

Electromobility is happening in the near future loads of. Therefore, your decision for the charging infrastructure will last for a long time. Therefore we give you on all products in the catalogue chapter „Charging infrastructure“ 5 instead of only 2 years warranty.



HOW CAN WE DO IT? SUPPORT?

The mobility of tomorrow: An exciting world. To the step in
We would like to make our contribution towards the future. To
one with products that allow you to work under high voltage
as simple as possible, but also as safe as necessary
make. On the other hand, with advice and help whenever you like.

Do you have a question? Are you unsure about a decision?
Are you looking for an individual solution? We stand by you
to the side at any time. You can reach our experts at:

info@efuturo.de



KS Tools Werkzeuge und Maschinen GmbH
Seligenstädter Grund 10-12
63150 Heusenstamm
Deutschland
Tel.: +49 (0)6104 4974-0
Fax: +49 (0)6104 4974-11
E-Mail: customerservice@kstools.com
www.kstools.com

